

# Lucid/Lucid-X Series RF Analog Signal Generator Desktop Model User Manual

Rev. 1.4

Distribution in the UK & Ireland



**Lambda Photometrics Limited**  
Lambda House Batford Mill  
Harpenden Herts AL5 5BZ  
United Kingdom  
E: [info@lambdaphoto.co.uk](mailto:info@lambdaphoto.co.uk)  
W: [www.lambdaphoto.co.uk](http://www.lambdaphoto.co.uk)  
T: +44 (0)1582 764334  
F: +44 (0)1582 712084



## Warranty Statement

Products sold by Tabor Electronics Ltd. are warranted to be free from defects in workmanship or materials. Tabor Electronics Ltd. will, at its option, either repair or replace any hardware products which prove to be defective during the warranty period. You are a valued customer. Our mission is to make any necessary repairs in a reliable and timely manner.

## Duration of Warranty

The warranty period for this Tabor Electronics Ltd. hardware is one year, except software and firmware products designed for use with Tabor Electronics Ltd. Hardware is warranted not to fail to execute its programming instructions due to defect in materials or workmanship for a period of ninety (90) days from the date of delivery to the initial end user.

## Return of Product

Authorization is required from Tabor Electronics before you send us your product for service or calibration. Call your nearest Tabor Electronics support facility. A list is located on the last page of this manual. If you are unsure where to call, contact Tabor Electronics Ltd. Tel Hanan, Israel at 972-4-821-3393 or via fax at 972-4-821-3388. We can be reached at: [support@tabor.co.il](mailto:support@tabor.co.il)

## Limitation of Warranty

Tabor Electronics Ltd. shall be released from all obligations under this warranty in the event repairs or modifications are made by persons other than authorized Tabor Electronics service personnel or without the written consent of Tabor Electronics.

Tabor Electronics Ltd. expressly disclaims any liability to its customers, dealers and representatives and to users of its product, and to any other person or persons, for special or consequential damages of any kind and from any cause whatsoever arising out of or in any way connected with the manufacture, sale, handling, repair, maintenance, replacement or use of said products.

Representations and warranties made by any person including dealers and representatives of Tabor Electronics Ltd., which are inconsistent or in conflict with the terms of this warranty (including but not limited to the limitations of the liability of Tabor Electronics Ltd. as set forth above), shall not be binding upon Tabor Electronics Ltd. unless reduced to writing and approved by an officer of Tabor Electronics Ltd. This document may contain flaws, omissions, or typesetting errors. No warranty is granted nor liability assumed in relation thereto. The information contained herein is periodically updated and changes will be incorporated into subsequent editions. If you have encountered an error, please notify us at [support@taborelec.com](mailto:support@taborelec.com). All specifications are subject to change without prior notice. Except as stated above, Tabor Electronics Ltd. makes no warranty, express or implied (either in fact or by operation of law), statutory or otherwise; and except to the extent stated above, Tabor Electronics Ltd. shall have no liability under any warranty, express or implied (either in fact or by operation of law), statutory or otherwise.

## Proprietary Notice

This document and the technical data herein disclosed, are proprietary to Tabor Electronics, and shall not, without express written permission of Tabor Electronics, be used, in whole or in part to solicit quotations from a competitive source or used for manufacture by anyone other than Tabor Electronics. The information herein has been developed at private expense and may only be used for operation and maintenance reference purposes or for purposes of engineering evaluation and incorporation into technical specifications and other documents, which specify procurement of products from Tabor Electronics.

## Document Revision History

Revision	Date	Description	Author
1.4	19-Oct-2023	<ul style="list-style-type: none"> <li>Updated document format.</li> <li>Added Lucid-X Desktop</li> <li>Release supporting Lucid Control Panel Ver. 1.3.400 and TE Update Tool Ver. 1.1.212, LS4091M SPI_SCPI Commands Rev 1.0, TEG SPI_SCPI Commands Rev 1.18, Lucid FPGA version 03092023 and Lucid-X FPGA version 03092023 or higher.</li> <li><a href="#">1.2 Related Documentation</a> – New.</li> <li><a href="#">Table 1.1 Ordering Information</a> – Added Lucid-X series.</li> <li><a href="#">2.1 Unpacking</a> – Updated.</li> <li>Chapter 3 “SPI Programming” — Moved to “Lucid/Lucid-X Programming Manual”.</li> <li><a href="#">4 Lucid Desktop Specifications</a> – Added Lucid-X series.</li> <li><a href="#">5 Appendix A. Lucid SPI Interface</a> — Added host setup.</li> </ul>	Jakob Apelblat
1.3	04-May-2021	<ul style="list-style-type: none"> <li>Release supporting Lucid SW Ver. 1.8.15, FPGA Ver. 18111215 for HW Ver. D, 221220 for HW Ver. E and Ver. 221220 for HW Ver. F, and SPI &amp; SCPI Commands List Summary Rev. 1.17.</li> <li><a href="#">1.3 Software Support</a> – New.</li> <li>Removed sections “Lucid Software Requirements”, “Installation”, “PC Control Software”, “Troubleshooting”, and “FPGA Firmware Update” that are included in the new “Lucid Control Panel User Manual”.</li> <li>Removed section SCPI Programming that is included in the new “Lucid Programming Manual”.</li> <li>Table 3.3 Set Frequency – Changed Min Value from 100 kHz to 9 kHz.</li> <li>Table 3.64 Set Sweep Start Frequency – Changed Min Value from 100 kHz to 9 kHz.</li> <li>Table 3.66 Set Sweep Stop Frequency – Changed Min Value from 100 kHz to 9 kHz.</li> <li>Table 3.5 Set Output Power – Changed Min Value and Max Value from “-90 to +15” to “-100 dBm to +20dBm”.</li> <li>Table 3.76 Set Sweep Start Power, page 44 – Changed Min Value and Max Value from “-90 to +15” to “-100 dBm to +20dBm”.</li> <li>Table 3.9 Set Run Mode – Changed values, and added Gate (set and query).</li> <li>Table 3.11 Set Trigger Source – New value SPI (set and query).</li> <li>Table 3.21 Set Trigger Timer – Changed Min Value from 100 <math>\mu</math>s to 1 <math>\mu</math>s.</li> <li>Table 3.99 Query Firmware – Changed Query Code from CB to EC.</li> <li>Table 5.4 Modulation Specification – Changed Sweep Dwell Time from “10 <math>\mu</math>s to 1,000 s” to “100 <math>\mu</math>s to 1,000 s”.</li> </ul>	Jakob Apelblat
1.2	6-Aug-2020	<ul style="list-style-type: none"> <li>Minor typos.</li> <li><a href="#">4 Lucid Desktop Specifications</a> – Updated.</li> </ul>	Jakob Apelblat

1.1	23-Jun-2020	<ul style="list-style-type: none"> <li>• Supporting Lucid. 1.2.x SW version.</li> <li>• Updated formatting, corrected typos, etc.</li> <li>• <a href="#">Figure 2.3 Rear Panel</a> – New photo.</li> <li>• <a href="#">Figure 2.2 Front Panel</a> – New photo.</li> <li>• <a href="#">2.3 Rear Panel Connectors</a> – EXT IO removed, SYNC OUT changed to SYNC IN.</li> <li>• Figure 3.4 CW &amp; Modulation Tab, page 28 – The status bar has a thermometer.</li> <li>• 3 SPI Programming – Updated according to SPI &amp; SCPI Commands List Summary Rev. 1.14</li> <li>• 4 SPI Programming – Updated according to SPI &amp; SCPI Commands List Summary Rev. 1.14</li> <li>• <a href="#">3.1.2 USB Device Driver Manual Installation (Windows 7)</a> – Updated step 10.</li> </ul>	Jakob Apelblat
1.0	26-Feb-2020	<ul style="list-style-type: none"> <li>• First edition supporting Lucid 1.1.0 SW version.</li> </ul>	Jonathan Netzer

## Acronyms & Abbreviations

Acronym	Description
μs or us	Microseconds
ADC	Analog to Digital Converter
AM	Amplitude Modulation
ASIC	Application-Specific Integrated Circuit
ATE	Automatic Test Equipment
AWG	Arbitrary Waveform Generators
AWT	Arbitrary Waveform Transceiver
BNC	Bayonet Neill–Concelm (coax connector)
BW	Bandwidth
CW	Carrier Wave
DAC	Digital to Analog Converter
dBc	dB/carrier. The power ratio of a signal to a carrier signal, expressed in decibels
dBm	Decibel-Milliwatts. E.g., 0 dBm equals 1.0 mW.
DDC	Digital Down-Converter
DHCP	Dynamic Host Configuration Protocol
DSO	Digital Storage Oscilloscope
DUC	Digital Up-Converter
ENoB	Effective Number of Bits
ESD	Electrostatic Discharge
EVM	Error Vector Magnitude
FPGA	Field-Programmable Gate Arrays
GHz	Gigahertz
GPIO	General Purpose Interface Bus
GS/s	Giga Samples per Second
GUI	Graphical User Interface
HP	Horizontal Pitch (PXIe module horizontal width, 1 HP = 5.08mm)
Hz	Hertz
IF	Intermediate Frequency
I/O	Input / Output

Acronym	Description
IP	Internet Protocol
IQ	In-phase Quadrature
IVI	Interchangeable Virtual Instrument
JSON	JavaScript Object Notation
kHz	Kilohertz
LCD	Liquid Crystal Display
LO	Local Oscillator
MAC	Media Access Control (address)
MDR	Mini D Ribbon (connector)
MHz	Megahertz
ms	Milliseconds
NCO	Numerically Controlled Oscillator
ns	Nanoseconds
PC	Personal Computer
PCAP	Projected Capacitive Touch Panel
PCB	Printed Circuit Board
PCI	Peripheral Component Interconnect
PXI	PCI eXtension for Instrumentation
PXIe	PCI Express eXtension for Instrumentation
QC	Quantum Computing
Qubits	Quantum bits
R&D	Research & Development
RF	Radio Frequency
RT-DSO	Real-Time Digital Oscilloscope
s	Seconds
SA	Spectrum Analyzer
SCPI	Standard Commands for Programmable Instruments
SFDR	Spurious Free Dynamic Range
SFP	Software Front Panel
SMA	Subminiature version A connector
SMP	Subminiature Push-on connector

Acronym	Description
SPI	Serial Peripheral Interface
SRAM	Static Random-Access Memory
TFT	Thin Film Transistor
T&M	Test and Measurement
TPS	Test Program Sets
UART	Universal Asynchronous Receiver-Transmitter
USB	Universal Serial Bus
VCP	Virtual COM Port
Vdc	Volts, Direct Current
V p-p	Volts, Peak-to-Peak
VSA	Vector Signal Analyzer
VSG	Vector Signal Generator
WDS	Wave Design Studio

# Contents

<b>DOCUMENT REVISION HISTORY .....</b>	<b>3</b>
<b>ACRONYMS &amp; ABBREVIATIONS .....</b>	<b>5</b>
<b>CONTENTS.....</b>	<b>8</b>
<b>FIGURES .....</b>	<b>9</b>
<b>TABLES .....</b>	<b>9</b>
<b>1 GENERAL.....</b>	<b>10</b>
1.1 SCOPE.....	10
1.2 RELATED DOCUMENTATION .....	12
1.3 SOFTWARE SUPPORT .....	12
1.4 DOCUMENT CONVENTIONS .....	13
1.5 SAFETY.....	13
1.6 MAINTENANCE .....	14
1.6.1 Preventive Maintenance .....	14
1.6.2 Long Term Storage or Repackaging For Shipment .....	14
<b>2 INTRODUCTION .....</b>	<b>15</b>
2.1 UNPACKING .....	15
2.2 FRONT PANEL CONNECTOR LUCID .....	16
2.3 REAR PANEL CONNECTORS LUCID.....	16
2.4 REAR PANEL CONNECTOR LUCID-X.....	18
2.5 FRONT PANEL CONNECTORS LUCID-X .....	19
<b>3 TROUBLESHOOTING .....</b>	<b>21</b>
3.1 MANUALLY INSTALLING INSTRUMENT DRIVERS .....	21
3.1.1 USB Device Driver Manual Installation (Windows 10).....	21
3.1.2 USB Device Driver Manual Installation (Windows 7).....	28
<b>4 LUCID DESKTOP SPECIFICATIONS .....</b>	<b>32</b>
4.1 FREQUENCY .....	32
4.2 FREQUENCY REFERENCE .....	32
4.3 AMPLITUDE.....	32
4.4 PHASE NOISE AND HARMONICS .....	33
4.5 MODULATION .....	34
4.6 INPUTS.....	35
4.7 OUTPUTS.....	36
4.8 GENERAL.....	37
<b>5 APPENDIX A. LUCID SPI INTERFACE.....</b>	<b>39</b>
<b>6 APPENDIX B. LUCID-X SPI INTERFACE TBD .....</b>	<b>41</b>



## Figures

Figure 1.1 LS1291D – 12 GHz, 1 Channel, Desktop Rf Analog Signal Generator.....	11
Figure 1.2 LSX2091D – 20 GHz 1 Channel, Desktop Microwave Signal Generator.....	12
Figure 2.1 Package and Contents of Lucid Desktop Model .....	16
Figure 2.2 Front Panel Lucid.....	16
Figure 2.3 Rear Panel Lucid.....	16
Figure 2.4 Rear Panel Lucid-X.....	18
Figure 2.5 Front Panel Lucid-X.....	19
Figure 5.1 SPI Connector Pin Numbering .....	39
Figure 5.2 SPI Connector Pad Description .....	39

## Tables

Table 1.1 Ordering Information .....	10
Table 4.1 Frequency Specifications.....	32
Table 4.2 Frequency Reference Specifications .....	32
Table 4.3 Amplitude Specifications.....	32
Table 4.4 Phase Noise and Harmonics Specifications.....	33
Table 4.5 Modulation Specifications .....	34
Table 4.6 Inputs Specifications .....	35
Table 4.7 Outputs Specifications.....	36
Table 4.8 General Specification .....	37
Table 5.1 SPI Connector Pin Description .....	39

# 1 General

## 1.1 Scope

The scope of this manual is to describe the setup and operating procedures of the Lucid/Lucid-X Series RF Analog Signal Generator. This covers the following models listed in the ordering information.

**Table 1.1 Ordering Information**

Model	Description
LS3081D	3 GHz, 1 channel, desktop RF analog signal generator
LS6081D	6 GHz, 1 channel, desktop RF analog signal generator
LS1291D	12 GHz, 1 channel, desktop RF analog signal generator
LSX2091D	20 GHz 1 channel, desktop microwave signal generator
LSX4091D	40 GHz 1 channel, desktop microwave signal generator
Options	
PLS	Pulse modulation
PAT	Pattern modulation
LP	Low power to -90 dBm
FS	Fast switching 100 $\mu$ s
EMU	Emulator for Keysight, R&S, Anapico & Holzworth

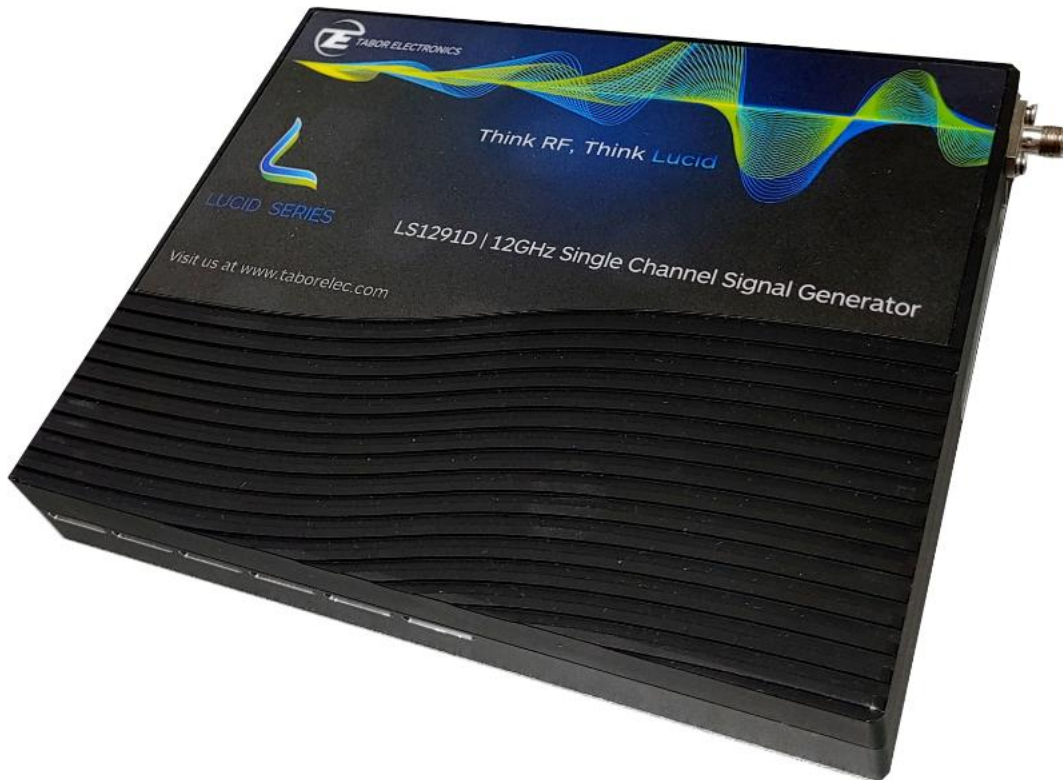

**Figure 1.1 LS1291D – 12 GHz, 1 Channel, Desktop Rf Analog Signal Generator**



Figure 1.2 LSX2091D – 20 GHz 1 Channel, Desktop Microwave Signal Generator

## 1.2 Related Documentation

- Lucid Control Panel User Manual
- TE Update Tool User Manual
- Lucid Lucid-X Programming Manual
- Tabor Lucid Multi-Channel RF Signal Generators White Paper
- Lucid Series Performance Verification Manual

## 1.3 Software Support

The **Lucid Control Panel** is a software package that comes on a CD supplied with the device. It enables full control and programming of your Tabor Electronics Lucid series RF analog signal generators via a user-friendly graphical user interface. The **TE Update Tool** is a utility for updating the Lucid device FPGA. The **Lucid Programming Manual** lists and describes the set of SCPI-compatible (Standard Commands for Programmable Instruments) remote commands used to operate the Lucid devices. The programs and the user manuals can be downloaded from the Tabor Electronics website at <http://www.taborelec.com/downloads>.

## 1.4 Document Conventions

Convention	Description	Example
Bold Writing	Indicates an item/message in the User Interface.	Click the <b>On</b> button.
<Angled and Bolded Brackets>	Indicates a physical key on the keyboard.	Press <Ctrl>+<B>.

---

### Caution!

A Caution indicates instructions, which, if not followed, may result in damage to the equipment or to the loss of data.

---

---

### Note

A Note provides additional information to help obtain optimal equipment performance.

---

---

### Idea

An Idea provides an alternate procedure to obtain the same results.

---

## 1.5 Safety

To avoid Electrical Shock, fire or personal injury:

- Use only the proper power cord specified for this manual and certified for the country of use.
- This product is grounded through the grounding conductor of the power cord. To avoid electrical shock, the grounding conductor must be connected to the ground. Before connecting to the power input or output, ensure that the product is properly grounded.
- Do not operate this product with removed covers or panels.
- Observe all the ratings and markings on the product. Search this manual for further rating information, before connecting to it. Do not apply potential that is higher than the maximum rating.
- Do not operate in dark or wet conditions.
- Do not operate in an explosive environment. Keep the product clean and dry.

## 1.6 Maintenance

### 1.6.1 Preventive Maintenance

There are no hardware adjustments within Lucid Generators. Tabor Electronics Ltd., recommends that the Lucid Generator is calibrated every 12 months or whenever a problem is suspected. The specific calibration interval depends upon the accuracy required. No periodic preventive maintenance is required.

### 1.6.2 Long Term Storage or Repackaging For Shipment

If the instrument is to be stored for a long period of time or shipped immediately, proceed as directed below. If you have any questions, contact your local Tabor Electronics representative or the Tabor Electronics Customer Service Department.

1. Repack the instrument using the wrappings, packing material and accessories originally shipped with the unit. If the original container is not available, purchase replacement materials.
2. Be sure the carton is well sealed with strong tape or metal straps.
3. Mark the carton with the model and serial number. If it is to be shipped, show sending and return address on two sides of the box.
4. If the instrument is to be shipped for service or repair, the following information must be included with the shipment:
  - Name and address of the owner.
  - Record the model and serial number of the instrument, options, and firmware version.
  - Note the problem and symptoms – detailed information will help in verifying the problem.
    - What was the instrument setup?
    - Did the unit work; then fail?
    - What other equipment was connected to the generator when the problem occurred?
  - The name and telephone number of someone familiar with the problem who can be contacted by Tabor Electronics if any further information is required.
  - Show the returned authorization order number (RMA) as well as the date and method of shipment.

---

#### Note

Always obtain a return authorization number from the factory before shipping the instrument to Tabor Electronics.

---



## 2 Introduction

The Lucid/Lucid-X series desktop models feature 3, 6, 12, 20 and 40 GHz single channel generator versions, all sharing the very same industry leading highlighted features, in a compact, small footprint module. Featuring extremely fast switching speed, superior signal integrity and purity, all the necessary modulated signals for analog communication systems, with built in SPI and micro-USB interface. The Lucid Series is designed to meet today's most demanding requirements that is needed from the R&D benches to the production lines.

### 2.1 Unpacking

Check that the packaging is undamaged. If packaging is damaged, notify the carrier immediately.

The Lucid/Lucid-X desktop model instrument is supplied with:

- Lucid power supply. Input 90 – 264 V AC, 1 A, 47-63 Hz. Output 12.0 V DC, 3.0 A, 36 W,  
Outside  Inside
- Lucid-X power supply. Input 100 – 240 V AC, 1.5 A, 47-63 Hz. Output 12.0 V DC, 8.34 A, 100.0 W,  
Outside  Inside
- Power cord with a plug according to customer country standard
- Lucid: USB to Micro USB cable for connecting a control PC to the instrument
- Lucid-X: USB Type-A to USB Type-C cable for connecting a control PC to the instrument
- Lucid software, user manual and instrument drivers can be downloaded from <https://www.taborelec.com/Downloads>.

---

#### Caution!

The Lucid Series RF Signal Generator ships in an antistatic package to prevent damage from electrostatic discharge (ESD). When storing the unit, use the antistatic case.

---



Figure 2.1 Package and Contents of Lucid Desktop Model

## 2.2 Front Panel Connector Lucid

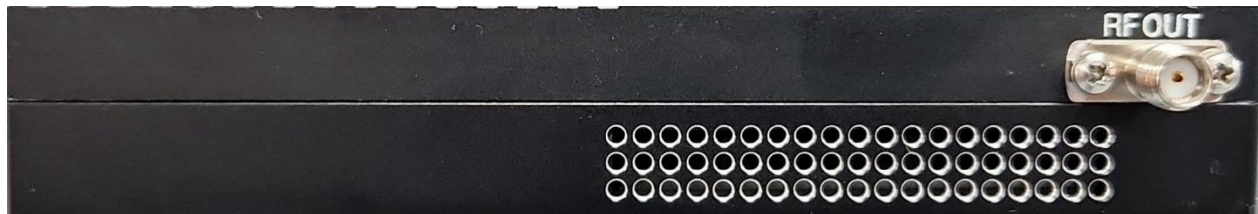

Figure 2.2 Front Panel Lucid

- RF OUT – SMA type connector for RF signal output

## 2.3 Rear Panel Connectors Lucid



Figure 2.3 Rear Panel Lucid

- PULSE/TRIG IN – MMCX type connector for pulse modulation or for trigger input



- AM IN – MMCX type connector for amplitude modulation input
- FM IN – MMCX type connector for frequency modulation input
- SYNC IN – MMCX type connector for Tabor Electronics factory use only
- Micro-USB – USB Micro-B interface for remote connection to PC
- SPI connector – SPI interface for remote connection to PC
- 10/100MHz IN – SMA type connector for 10 MHz or 100 MHz signal input
- 10 MHz OUT – SMA type connector for 10MHz signal output
- 100 MHz OUT – SMA type connector for 100MHz signal output
- Power – 12V power supply connector

---

**Notes**

For a detailed description of the SPI connector please refer to [5 Appendix A. Lucid SPI Interface](#).

The Lucid generator will automatically revert to external reference when a signal is detected at its input.

---

## 2.4 Rear Panel Connector Lucid-X



**Figure 2.4 Rear Panel Lucid-X**

- Power 12VDC – 12V power supply connector
- SPI connector – SPI interface for remote connection to PC
- SYNC X – MMCX type connector for Tabor Electronics factory use only
- SYNC I/O – MMCX type connector for Tabor Electronics factory use only
- USB Device/Host – USB Type-C interface for remote connection to PC

**Note**

For a detailed description of the SPI connector please refer to [Appendix B. Lucid-X SPI Interface TBD.](#)

## 2.5 Front Panel Connectors Lucid-X



**Figure 2.5 Front Panel Lucid-X**

- CLK OUT 3GHz – SMA type connector for 3 GHz signal output
- AM – SMP type connector for amplitude modulation input
- CLK IN – SMA type connector for 3 GHz signal input
- FM – SMP type connector for frequency modulation input
- REF IN 10/100MHz – SMA type connector for 10 MHz or 100 MHz signal input
- PULSE/TRIG – SMP type connector for pulse modulation or for trigger input
- REF OUT 10/100MHz – SMA type connector for 10/100 MHz signal output
- Status – LED
  - On – RF OUT port is active
  - Off – RF OUT port is not active

- RF OUT – 2.4 mm type connector for RF signal output

---

**Note**

The Lucid generator will automatically revert to external reference when a signal is detected at its input.

---

## 3 Troubleshooting

### 3.1 Manually Installing Instrument Drivers

#### 3.1.1 USB Device Driver Manual Installation (Windows 10)

5. Download the latest Lucid series USB device driver from [www.taborelec.com/downloads](http://www.taborelec.com/downloads). Using the supplied USB cable, connect the Lucid desktop model to the PC.
6. Open the **Start** menu, and in the search field, type Device Manager.

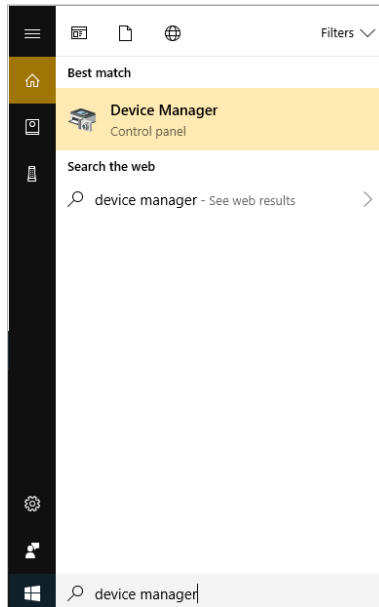

7. In the search results list, select Device Manager.  
The Device Manager window opens.

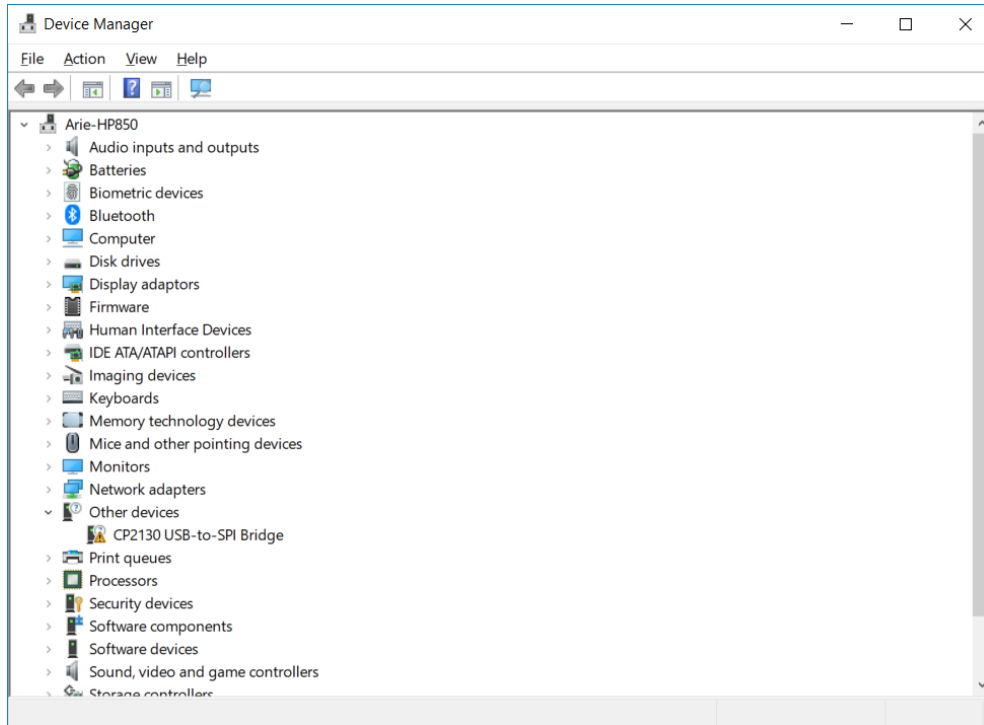

8. In the navigation tree, expand Other devices and double click on CP2130 USB-to-SPI Bridge.

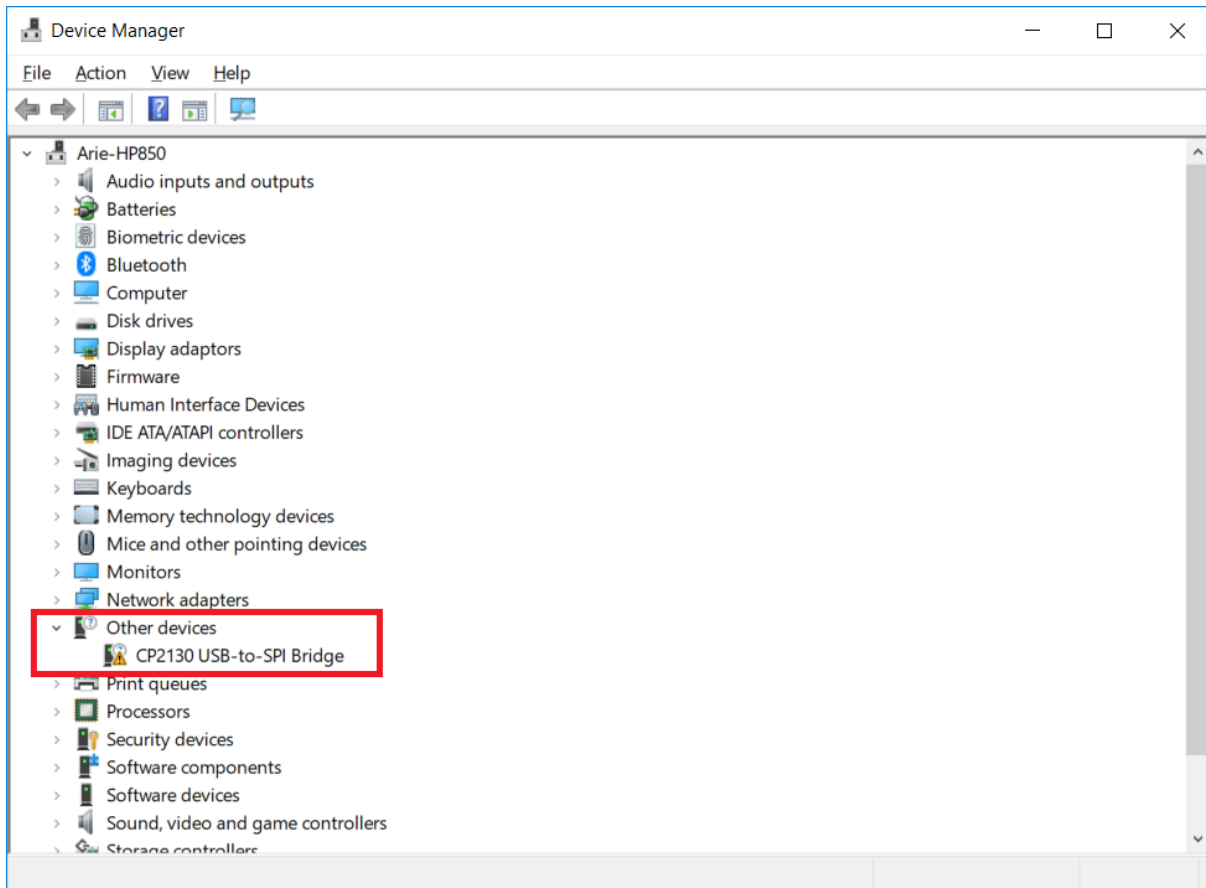

9. The CP2130 USB-to-SPI Bridge Properties window opens.  
Click Update Driver.

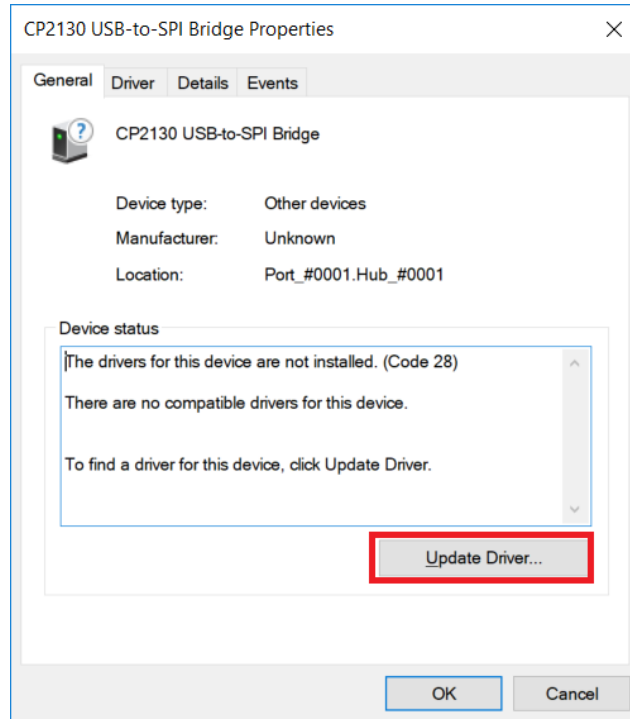

10. In the Update Drivers - CP2130 USB-to-SPI Bridge window, select Browse my computer for driver software.

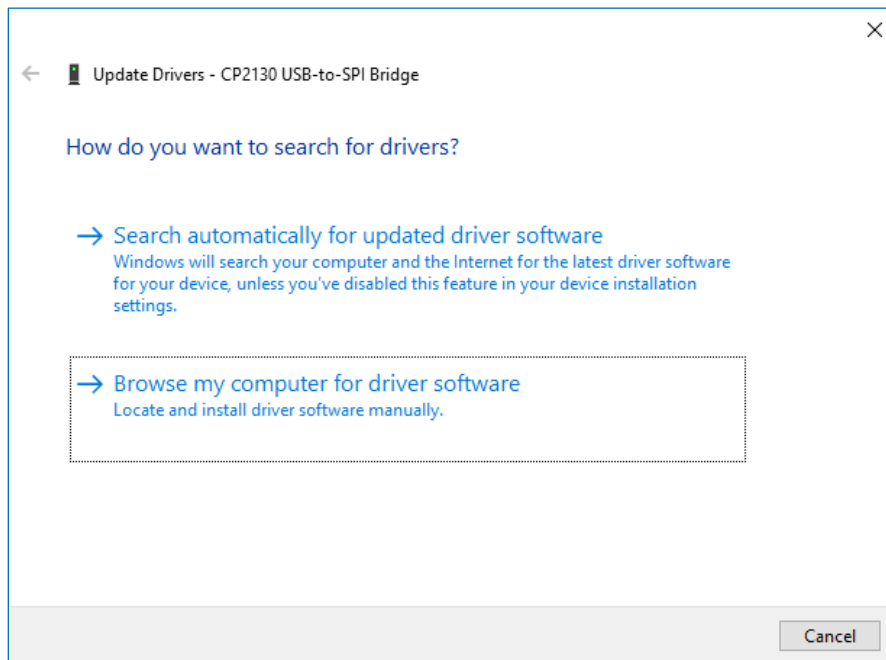

11. Browse to the driver software location on PC, select the file and click OK.



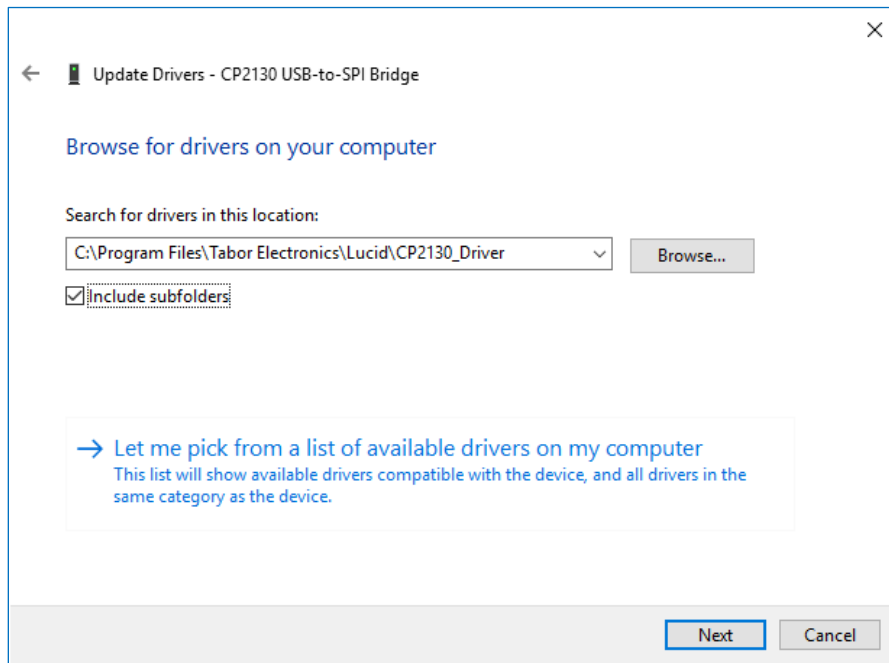

## 12. Driver download begins.

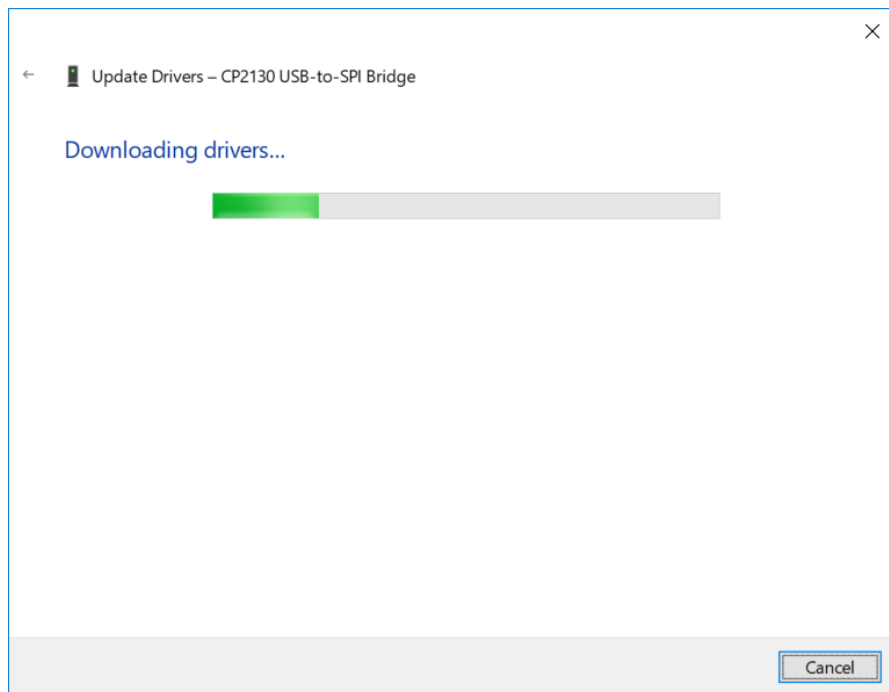

13. After the download is complete, the driver installation begins.

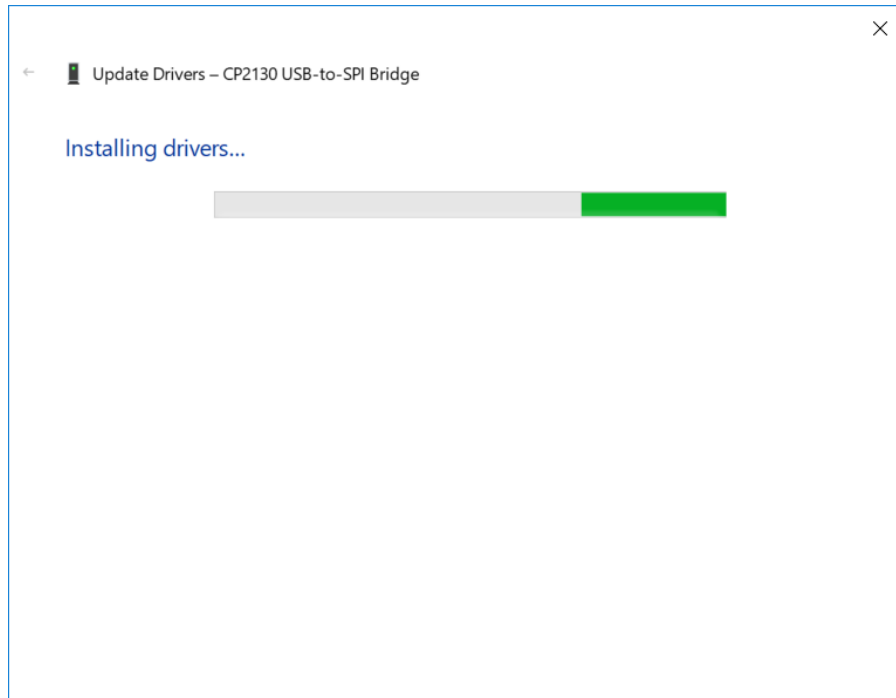

14. After the installation is complete, the following success message is displayed:

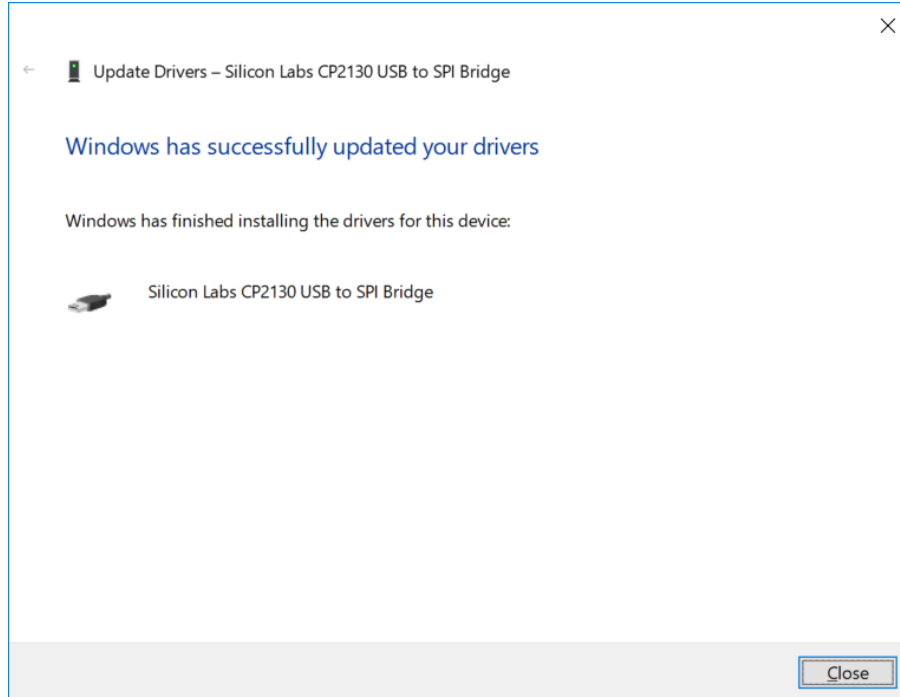

15. Click Close to close the Update Drivers window and to proceed.

16. In the CP2130 USB-to-SPI Bridge Properties window the displayed device status should be: **The device is working properly.**

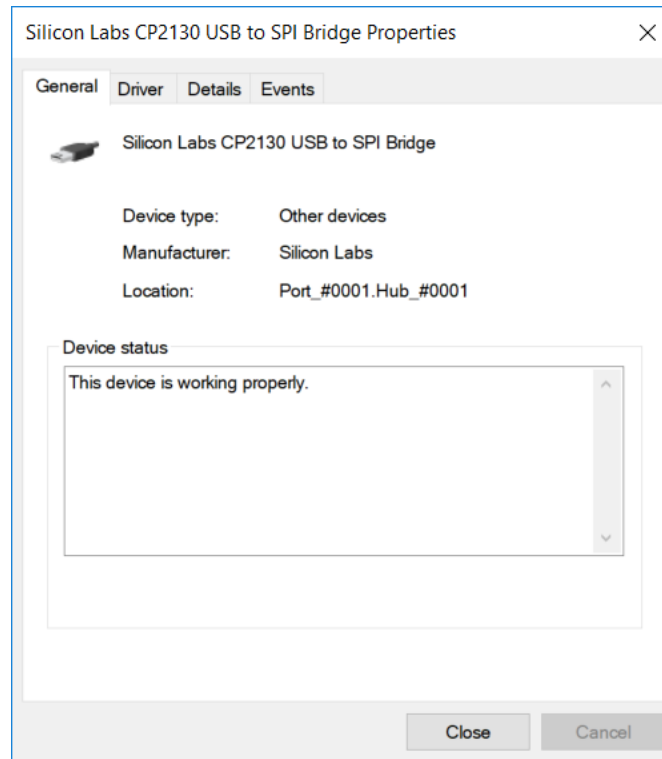

### 3.1.2 USB Device Driver Manual Installation (Windows 7)

1. Download the latest Lucid series USB device driver from the Tabor Electronics Ltd., website. Device drivers are available at [www.taborelec.com/downloads](http://www.taborelec.com/downloads)
2. Connect the Lucid Generator to the PC using the supplied USB Cable.

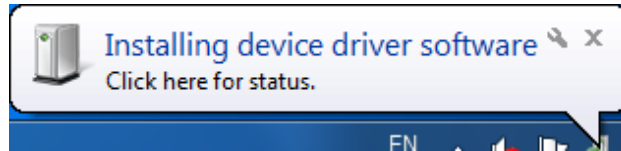

The Installing Device Driver Software message is displayed at the lower-right part of the screen.

3. Wait for the following messages to appear:

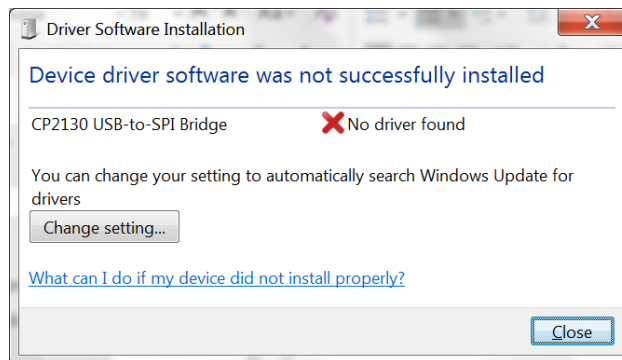

4. Click **Close**.
5. Open the **Start** menu, and in the search field, type Device Manager.
6. In the search results list, select Device Manager. The Device Manager window opens.
7. In the navigation tree, expand Other devices and select CP2130 USB-to-SPI Bridge.

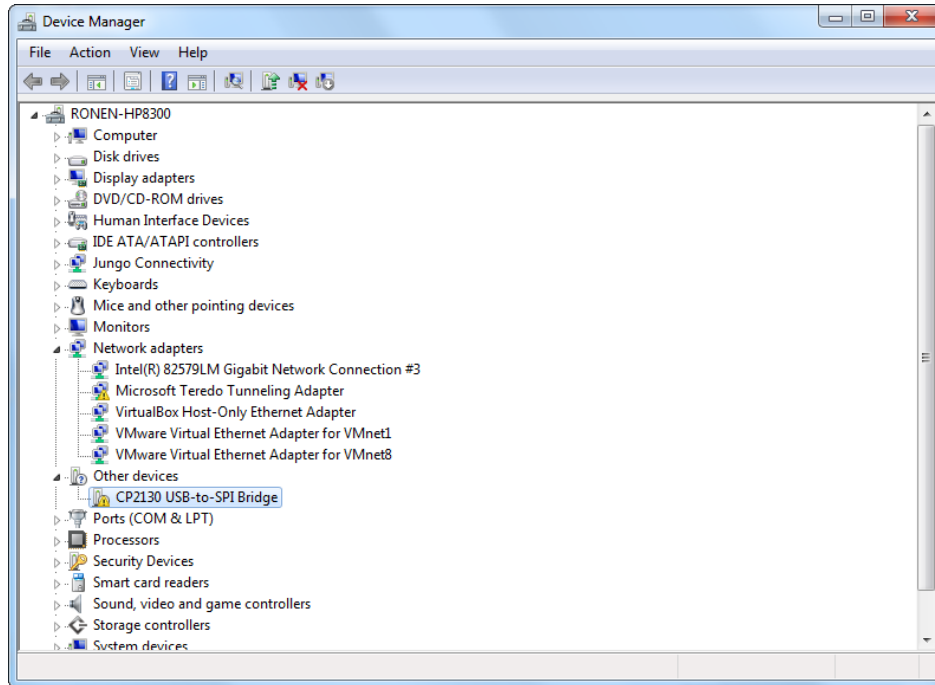

8. Right-click on CP2130 USB-to-SPI Bridge and select **Update Driver Software...** from the drop-list menu.
9. In the Update Drivers - CP2130 USB-to-SPI Bridge window, select Browse my computer for driver software.

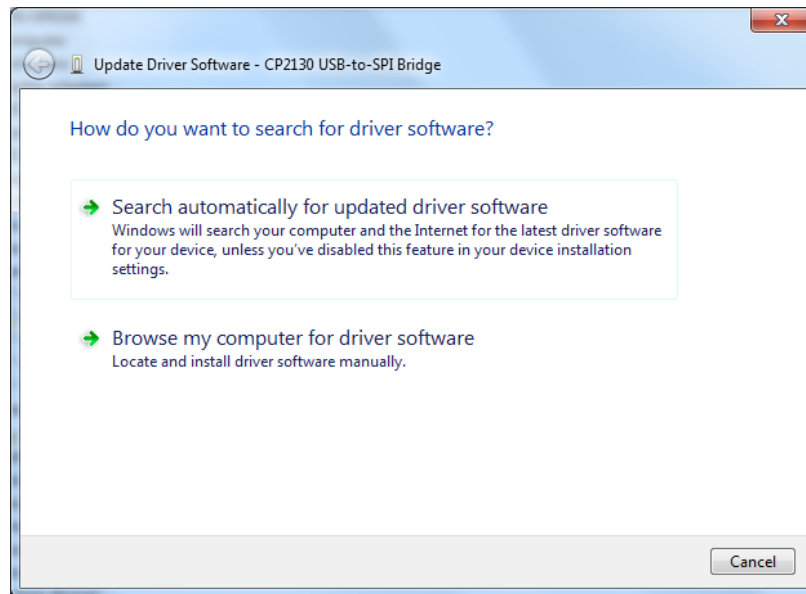

10. Browse to the driver software location on PC, select the folder and click Next. Driver installation begins.

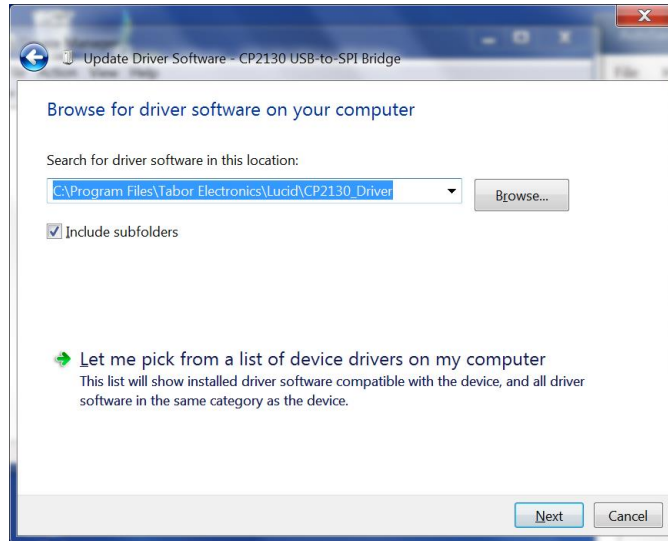

11. After the driver software installation is complete, click Close.

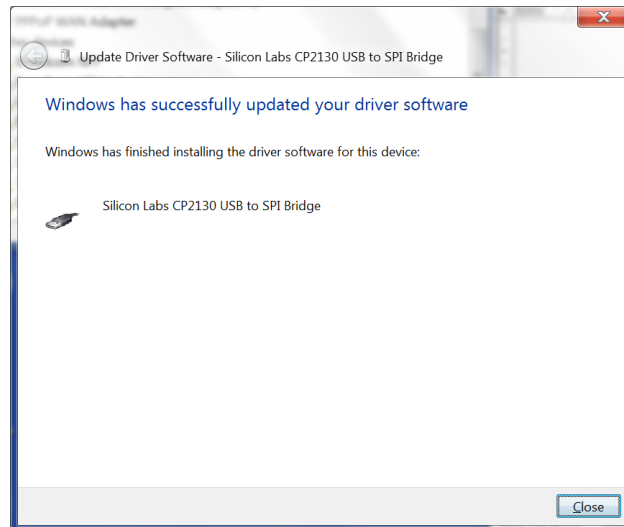

12. In the Device Manager, under Silicon Labs USB Devices, click **Silicon Labs CP2130 USB to SPI Bridge**.

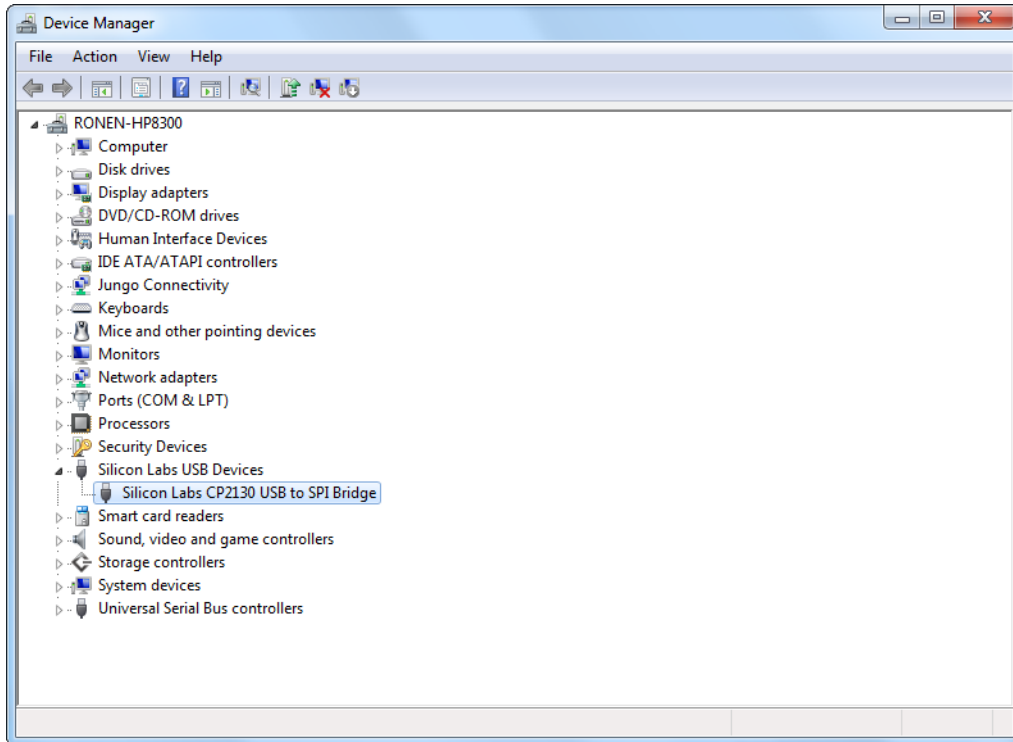

13. In the CP2130 USB-to-SPI Bridge Properties window the device status should indicate the device is working properly.

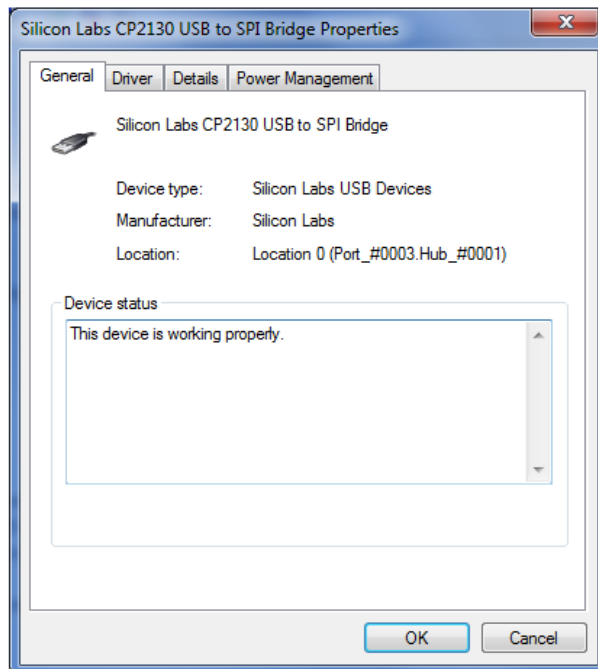

## 4 Lucid Desktop Specifications

### 4.1 Frequency

Table 4.1 Frequency Specifications

Frequency	
Range	
LS3081D	9 kHz to 3 GHz
LS6081D	9 kHz to 6 GHz
LS1291D	9 kHz to 12 GHz
LSX2091D	100 kHz to 20 GHz
LSX4091D	100 kHz to 40 GHz
Resolution	0.001 Hz
Phase Offset	0.01 deg
Switching Speed	
Standard	500 $\mu$ s
FS Option	100 $\mu$ s

### 4.2 Frequency Reference

Table 4.2 Frequency Reference Specifications

Frequency Reference	
Temperature Stability	$\pm$ 25 ppb max
Aging	$\pm$ 3 ppm max for 20 years
Warm Up time	30 min

### 4.3 Amplitude

Table 4.3 Amplitude Specifications

Amplitude	Lucid		Lucid-X	
Max Output Power				
Settable	+20 dBm		+15 dBm	
Calibrated	+15 dBm <sup>1</sup>		+10 dBm	
Min Output Power	Base	LP Opt.	Base	LP Opt.
Settable	-30 dBm	-100 dBm	-70 dBm	-80 dBm



Amplitude	Lucid		Lucid-X	
Calibrated	-20 dBm	-80 dBm	-50 dBm	-70 dBm
Resolution	0.01 dB		0.01 dB	
Power Mute	-95 dBm		-70 dBm	
Output Return Loss	-10 dBm		-10 dBm	
Accuracy (dB)	-50 dBm to +15 dBm	-90 dBm to -50 dBm	-50 dBm to +15 dBm	
Up to 100 MHz	±0.3 (typ.)	±0.5 (typ.)	±0.3 (typ.)	
100 MHz to 3 GHz	±0.4 (typ.)	±0.6 (typ.)	±0.4 (typ.)	
3 GHz to 9 GHz	±0.7 (typ.)	±0.9 (typ.)	±0.7 (typ.)	
Above 9 GHz	±1 (typ.)	±1.5 (typ.)	±1 (typ.)	

<sup>1</sup> Above 25 kHz.

## 4.4 Phase Noise and Harmonics

**Table 4.4 Phase Noise and Harmonics Specifications**

Phase Noise (dBc/Hz)	Lucid	Lucid-X	
Measured @ 10 kHz Offset)			
100 MHz		-155 (typ.)	
250 MHz		-147 (typ.)	
500 MHz		-141 (typ.)	
1 GHz	-138 (typ.)	-134 (typ.)	
2 GHz	-133 (typ.)	-128 (typ.)	
3 GHz	-130 (typ.)		
4 GHz		-123 (typ.)	
6 GHz	-124 (typ.)		
8 GHz		-116 (typ.)	
10 GHz		-115 (typ.)	
12 GHz	-118 (typ.)		
20 GHz		-109 (typ.)	
40 GHz		-103 (typ.)	
Harmonics (dBc)	Lucid	Lucid-X	
Range		0 dBm	+10 dBm
Up to 100 MHz	-30 dBc		

Up to 8 GHz:	-50 dBc	-50 dBc	-42 dBc
100 MHz to 12 GHz	-50 dBc <sup>2</sup>		
8 GHz to 20 GHz		-40 dBc	-32 dBc
20 GHz to 40 GHz		-35 dBc	-28 dBc
<b>Sub-harmonics (dBc)</b>	<b>Lucid</b>	<b>Lucid-X</b>	
6 to 12 GHz:	-55 dBm		
Up to 20 GHz:		-75 dBc (typ.)	
20 to 40 GHz:		-35 dBc (typ.)	
<b>Non-harmonics (dBc)</b>	<b>Lucid</b>	<b>Lucid-X</b>	
Up to 12 GHz	-90 dBc (typ.) <sup>3,4</sup> , -60 dBc (max.) <sup>5</sup>		
Up to 40 GHz		-90dBc (typ.)	-60dBc (max.) <sup>5</sup>

<sup>2</sup> 750 MHz to 900 MHz -35dBc (typ.).

<sup>3</sup> -60 dBm max. @ 1 GHz, 1.5 GHz, 2.5 GHz and 3 GHz.

<sup>4</sup> -75 dBm max. @ -15 dBm to +15 dBm and f > 6 GHz.

<sup>5</sup> Boundary spurs which may appear @ -100 MHz to +100 MHz offset from CW.

## 4.5 Modulation

**Table 4.5 Modulation Specifications**

Modulation	Lucid	Lucid-X
Frequency Modulation		
Maximum Deviation	10 MHz	10 MHz
Resolution	0.1 % or 1 Hz (the greater)	0.1 % or 1 Hz (the greater)
Modulation Rate	1 MHz	1 MHz
Resolution	1 Hz	1 Hz
Amplitude Modulation		
AM Depth		
Type	Linear	Linear
Maximum Settable	90 %	100%
Resolution	0.1 % of depth	0.1 % of depth
Modulation Rate	DC to 100 kHz	DC to 100 kHz
Phase Modulation		
Peak Deviation	360 deg	360 deg
Modulation Rate	DC to 100 kHz	DC to 100 kHz

Modulation	Lucid	Lucid-X
<b>Pulse Modulation (PLS Option)</b>		
On/off Ratio	60 dB	70dB
Rise/fall Time (10%-90%)	15 ns (typ.)	15 ns (typ.)
Resolution	6.4 ns	10 ns
Minimum Width	32 ns	30 ns
Repetition Frequency	DC to 10 MHz	DC to 10 MHz
<b>Pattern Modulation (PAT Option)</b>		
Number of Steps	1 to 2,048	1 to 2,048
Step Repetitions	1 to 65,535	1 to 65,535
ON/Off Time	32 ns to 20 days	20 ns to 20 days
<b>Sweep</b>		
Range	Same as frequency range	Same as frequency range
Modes	Frequency and amplitude step, list	Frequency and amplitude step, list
Dwell Time	100 $\mu$ s to 1,000 s	100 $\mu$ s to 1,000 s
Resolution	1 $\mu$ s	1 $\mu$ s
<b>Number of Points</b>		
List	2 to 4,096	2 to 4,096
Step	2 to 65,535	2 to 65,535
Step Change	Linear	Linear
Trigger	Free run, External, Bus, Timer	Free run, External, Bus, Timer

## 4.6 Inputs

**Table 4.6 Inputs Specifications**

Inputs	Lucid	Lucid-X
Pulse/Trigger Input	PULSE/TRIG IN	PULSE/TRIG
Connector Type	MMCX	SMP
Input Impedance	50 $\Omega$	50 $\Omega$
Input Voltage	TTL, CMOS compatible	TTL, CMOS compatible
Threshold	1.5 V	1.5 V
Damage level	-0.42 V or +5.42 V	-0.42 V or +5.42 V
AM Input	AM IN	AM

Inputs	Lucid	Lucid-X
Connector Type	MMCX	SMP
Input Impedance	50 Ω	50 Ω
Maximum Input Voltage	±1 V	±1 V
Input Damage Level	±3.5 V	±3.5 V
FM Input	FM IN	FM
Connector Type	MMCX	SMP
Input Impedance	50 Ω	50 Ω
Maximum Input Voltage	±1 V	±1 V
Input Damage Level	±3.5 V	±3.5 V
AM Input		
Clock Input 3 GHz		CLK IN 3GHz
Connector Type		SMA
Input Impedance		50 Ω
Waveform		Sine
Frequency		2.7 GHz/3.0 GHz/3.3 GHz
Power		+10 dBm
Absolute Maximum Level		+12 dBm
10/100 MHz Input	10/100MHz IN	REF IN 10/100MHz
Connector Type	SMA	SMP
Input Impedance	50 Ω	
Waveform	Sine or Square	
Frequency	10 MHz/100 MHz	
Power	-3 dBm to +10 dBm	
Absolute Maximum Level	+15 dBm	

## 4.7 Outputs

**Table 4.7 Outputs Specifications**

Outputs	Lucid	Lucid-X
RF Output	RF OUT	RF OUT
Impedance	50 Ω	50 Ω
Connector Type	SMA	2.4 mm
Number of Outputs	1	1

Outputs	Lucid	Lucid-X
10 MHz Output	10MHz OUT	REF OUT 10/100MHz
Impedance	50 $\Omega$	50 $\Omega$
Connector Type	2 x SMA	SMA
Frequency	10 MHz, 100 MHz	10 MHz, 100 MHz
Shape	Sine	Sine
Power	3 to 7 dBm	3 to 7 dBm
Clock Output		CLK OUT 3GHz
Connector Type		SMA
Input Impedance		50 $\Omega$
Waveform		Sine
Frequency		2.7 GHz/3.0 GHz/3.3 GHz
Power		+10 dBm
Absolute Maximum Level		+12 dBm

## 4.8 General

**Table 4.8 General Specification**

General	Lucid	Lucid-X
Voltage Range	+12.0 to +12.6 VDC	+12.0 to +12.6 VDC
Power Consumption		
Normal Operation	18 W nom.	30 W
Max	24 W max.	TBD.
Interface		
Device (remote connection to PC)	1 x micro-USB, 1 x SPI	1 x USB Type-C, 1 x SPI
Dimensions (WxHxD)	12 x 16 x 2.5 cm	14.5 x 9.5 x 3 cm
Weight		
Without Package	1 kg	1 kg
Shipping Weight	1.5 kg	1.5 kg
Temperature		
Operating	0°C to +40°C	0°C to +40°C
Storage	-40°C to +70°C	-40°C to +70°C
Warm up time	15 minutes	15 minutes

Humidity:	85% RH, non-condensing	85% RH, non-condensing
Safety	CE Marked, IEC61010-1:2010	CE Marked, IEC61010-1:2010
EMC	IEC 61326-1:2013	IEC 61326-1:2013
Calibration	2 years	2 years
Warranty	3 year standard	3 year standard

## 5 Appendix A. Lucid SPI Interface

### Host Setup

- SPI Mode: Sampling on rising edge and transmit on rising edge
- Level: LVTTLL (3.3 V)
- Bit order: MSB first
- Clock rate: Up to 10 MHz

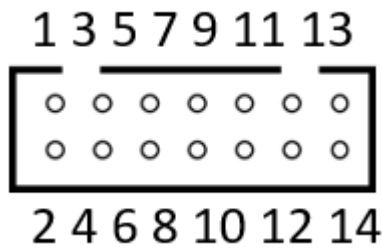

Figure 5.1 SPI Connector Pin Numbering

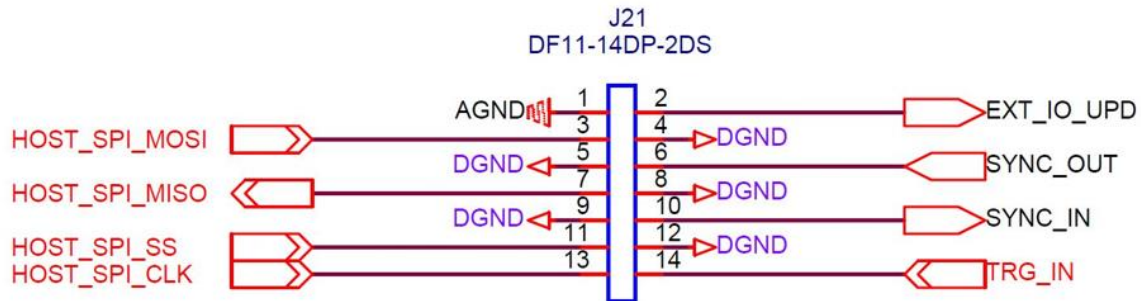

Figure 5.2 SPI Connector Pad Description

The SPI hardware interface consists of a standard SPI interface plus additionally assigned lines as defined in the table below.

Table 5.1 SPI Connector Pin Description

Signal	Description	Pin
SPI_MOSI	Master Out, Slave In. Command and query data sent from remote PC (Master) to Instrument (Slave).	3
SPI_MISO	Master In, Slave Out. Data sent from the instrument to the remote PC.	7
SPI_CLK	SPI clock, supplied by remote PC	13

Signal	Description	Pin
SPI_SS	Slave Select. This line uses an active low logic. Before data is sent to the instrument the line goes low and when done the line is made high again.	11
EXT_IO_UPD	For factory use only. Do not connect	2
SYNC_OUT	For factory use only. Do not connect	6
SYNC_IN	For factory use only. Do not connect	10
TRG_IN	When enabled the trigger signal to the instrument can initiate a signal, a frequency change or step through a sweep or list.	14
GND		1,4,5,8,9,12

Distribution in the UK & Ireland



**Characterisation,  
Measurement &  
Analysis**

**Lambda Photometrics Limited**  
 Lambda House Batford Mill  
 Harpenden Herts AL5 5BZ  
 United Kingdom  
 E: [info@lambdaphoto.co.uk](mailto:info@lambdaphoto.co.uk)  
 W: [www.lambdaphoto.co.uk](http://www.lambdaphoto.co.uk)  
 T: +44 (0)1582 764334  
 F: +44 (0)1582 712084