



AIM & THURLBY THANDAR INSTRUMENTS

TGP3100 Series



Advanced Pulse and Universal Generators - Single or Dual Channel

True pulse generator operation including low jitter asynchronous pulses

50MHz pulses, 0.1ns period and delay resolution, fully variable rise/fall

50Mbps pulse pattern generation up to 65536 bits with preamble

Noise generator with user-defined bandwidth and amplitude density

High performance 50MHz/800MS/s arbitrary/function generator

Programmable via USB, GPIB and LXI compliant LAN interfaces

Distribution in the UK & Ireland

aimtti.com



Lambda Photometrics Limited
Lambda House Batford Mill
Harpenden Herts AL5 5BZ
United Kingdom

**Characterisation,
Measurement &
Analysis**

E: info@lambdaphoto.co.uk
W: www.lambdaphoto.co.uk
T: +44 (0)1582 764334
F: +44 (0)1582 712084

TGP3100 Series

Pulse and Universal Generators

single or dual channels, 50MHz or 25MHz

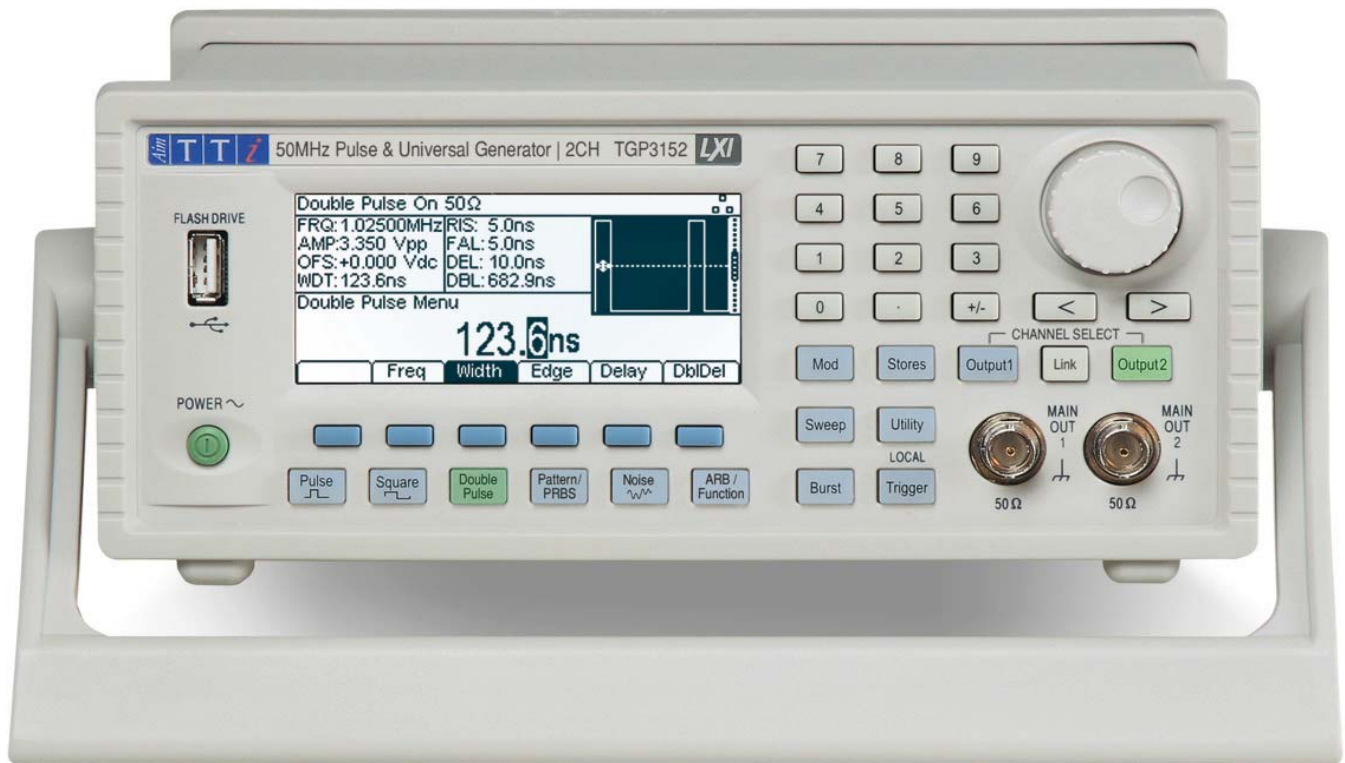

- ▶ Pulse waveforms from 1MHz to 50MHz, minimum rise time 5ns
- ▶ Very low jitter synchronous and asynchronous operation
- ▶ Pulse, double pulse, pulse pattern and PRBS waveforms
- ▶ Pulse period, width and delay resolutions of 100ps or 11 digits
- ▶ Independently variable rise and fall times from 5ns to 800 seconds
- ▶ True low jitter asynchronous operation, externally triggered pulses or pulse reconstruction
- ▶ High drive capability output can provide 20V pk-pk into 50Ω (unmatched)
- ▶ Wide range of pulse modulations including AM, FM, PM, FSK, BPSK, SUM, PWM, PDM using internal or external modulation sources.
- ▶ Triggered (burst count) or gated operation using internal or external trigger sources
- ▶ Full Noise generator to 25MHz with selectable crest factor and user defined distribution
- ▶ Full Arbitrary/Function generator with 16 waveform types - sine waves up to 50MHz
- ▶ Arbitrary waveforms at 800MS/s sampling rate and 16-bit vertical resolution
- ▶ Internal channel coupling, tracking and modulations (2 channel models)
- ▶ Extensive internal/external modulation of all waveform types
- ▶ Linear and logarithmic sweeps of all waveform types
- ▶ Front panel mounted USB Flash drive interface
- ▶ GPIB, USB and LXI compliant LAN interfaces

True Pulse Generators

The TGP3100 Series are true pulse generators using all digital techniques. They can replicate the capabilities of traditional pulse generators whilst adding many additional facilities such as pulse modulations.

Unlike DDS based function generators the TGP3100 Series can generate pulses up to 50MHz with very low jitter and high resolution of width and delay (100ps). They can also operate in an asynchronously triggered mode with low jitter.

A high drive capability output stage enables up to 20 volts pk-pk to be driven into a 50 Ohm load.

- with Universal Waveform capabilities

As well as operating as pulse generators, the instruments can act as high performance noise generators and as function/arbitrary generators - making them truly universal waveform generators.

Noise Generator

As a noise generator, the TGP3100 series offers fully variable noise bandwidth from 1mHz up to 25MHz.

Noise amplitude distribution can be Gaussian (with variable crest factor) or fully user defined.

Function Generator

The TGP3100 Series can operate as a high performance function generator at up to 50MHz.

Sixteen standard waveforms include sine, square, triangle, ramps, sinc, cardiac, plus logarithmic, exponential and gaussian shapes.

Arbitrary Generator

With an 800MS/s sample clock, the TGP3100 series can perform as high speed arbitrary generators with 16-bit vertical resolution and up to 4096 waveform points.

Application Examples

- ▶ Stress testing designs adding defined jitter and or delay
- ▶ Clock frequency simulation, with glitch-free pulse parameter changes
- ▶ Data sequencing patterns for Serial data testing (Pattern Generation)
- ▶ Asynchronous pulse signal conditioning
- ▶ Op Amp slew rate and asymmetrical characterisation
- ▶ Propagation delay testing

Model Range

TGP3121	25MHz, 1 channel
TGP3151	50MHz, 1 channel
TGP3122	25MHz, 2 channels
TGP3152	50MHz, 2 channels

More Information

Pulse Generator Operation	Pages 4 - 5
Pattern Generator Operation	Page 5
Noise Generator Operation	Page 6
Arbitrary Generator Operation	Page 6
Function Generator Operation	Pages 6 - 7
Two Channel Operation (TGP31x2)	Page 8
Locking to Other Sources/Generators	Page 8
File System and External Storage	Page 9
Remote Interfaces	Page 9
Rack and Bench Mounting	Page 9
Technical Specifications	Pages 10 - 12

Pulses at up to 50MHz

The TGP3100 Series offers pulse repetition rates of up to 50MHz combined with precise control of pulse width, pulse delay and edge speeds.

Exceptional Pulse Precision

The TGP3100 Series offers pulse widths from 10ns to 800s with a resolution of 100ps. Pulse delay has a similar range and resolution. This differs markedly from the pulse function of most DDS function generators where width and delay are defined by the system clock period and are one to two orders of magnitude less precise.

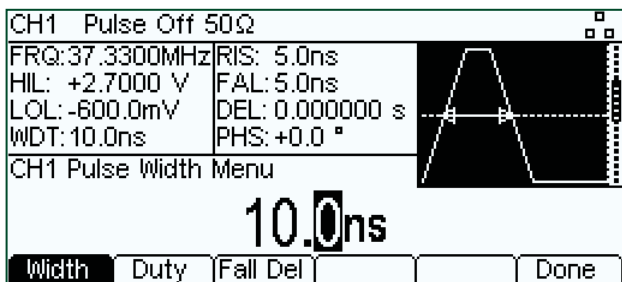

Pulse repetition frequency can be set between 1mHz and 50MHz (25MHz for TGP312x models) with up to 11 digits of resolution.

Independently variable Rise and Fall times

The main output has a best rise time of 5ns (8ns on TGP312x models) and has fully variable edge times up to hundreds of seconds to a resolution of 0.1ns.

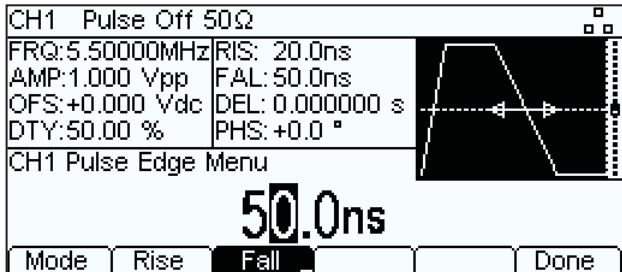

Rise and fall can be set together, or set independently. There are no limitations on rise time imposed by the pulse width.

High Drive Capability Output

The TGP3100 Series incorporates output amplifiers with higher drive capability than conventional generators. This enables it to drive 20 volts pk-pk into a 50Ω load.

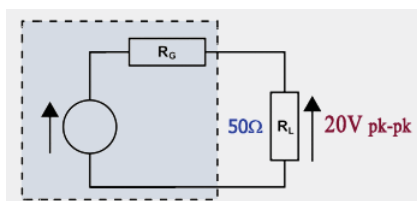

Switchable output impedance allows full load-source matching when levels below 11 volts pk-pk are sufficient.

Multi-stage attenuation allows signal levels down to 100mV pk-pk without sacrifice of dynamic range.

Low Jitter Asynchronous Operation

Unlike a function generator, the TGP3100 Series can generate pulses in response to an external trigger signal with minimal jitter.

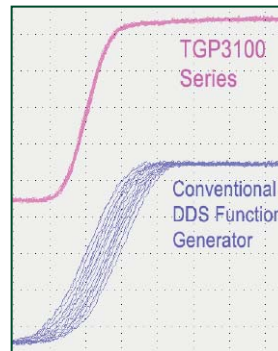

It achieves this using a compensation system that conventional generators can not replicate.

Asynchronous pulse generation mode retains the ability to set width, delay and edge times with high precision.

Comparison of repetitive asynchronously triggered pulses - TGP3100 Series and a conventional generator.

Pulse Delay Generation

The combination of low-jitter asynchronous operation with high resolution pulse delay setting enables the TGP3100 Series to operate as highly accurate delay generators.

Pulse Reconstruction

A further asynchronous mode allows the pulse output to follow both edges of the trigger signal, thus acting as a pulse reconstruction engine with fully variable level and edge speed.

Triggered or Gated Operation

Pulses can be triggered or gated using either an external trigger source, the remote interfaces, the manual trigger key, or the internal trigger generator (2mHz to 50MHz range).

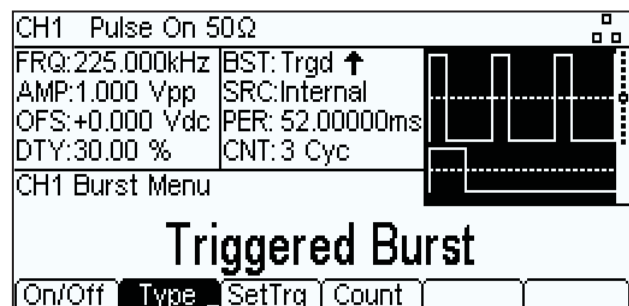

Triggered bursts can be from 1 to 4,294,967,295 cycles or infinite.

Replacing Older Pulse Generators

The TGP3100 Series can replace older type pulse generators manufactured by Hewlett Packard, Racal, Philips, Wavetek and others within existing test systems.

This is because of the true pulse generator characteristics that include asynchronous operation.

The IVI driver provides a recognised command set for easy incorporation into existing systems.

Double Pulse Operation

Double pulse mode generates two identical pulses in each cycle with fully variable delay between the two. All other pulse mode capabilities are retained.

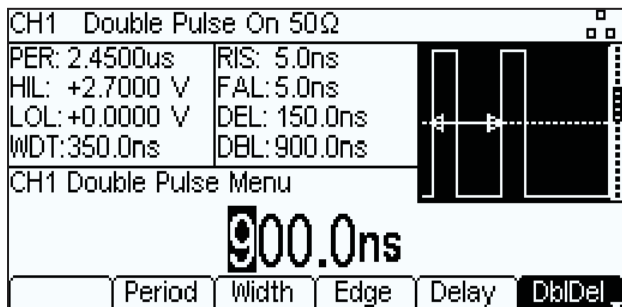

An additional modulation mode allows the delay between pulses to be modulated.

Pattern Generation

The TGP3100 Series can generate user defined patterns of up to 65536 bits at speeds up to 50Mbps (25Mbps on TGP312x models). Edge speeds are fully variable.

Four patterns can be stored internally with any number of patterns storable using the Flash drive interface.

Each pattern can be allocated a "preamble" which is a part of the pattern that is only played once, with the remainder being repeated continuously or as defined by burst settings.

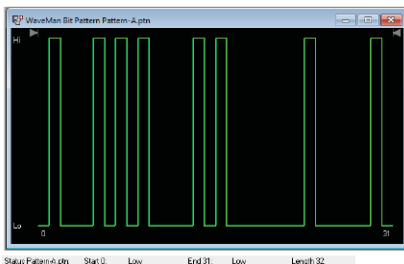

Patterns can be created or edited using the built-in pattern editor, or externally on a PC using the supplied Waveform Manager Plus software.

PRBS Generation

PRBS (Pseudo-Random Bit Sequence) is available at speeds up to 50Mbps (25Mbps on TGP312x models). Edge speeds are fully variable.

A PRBS is a binary waveform with a sequence that is almost impossible to predict. PRBS waveforms are used within secure communications systems.

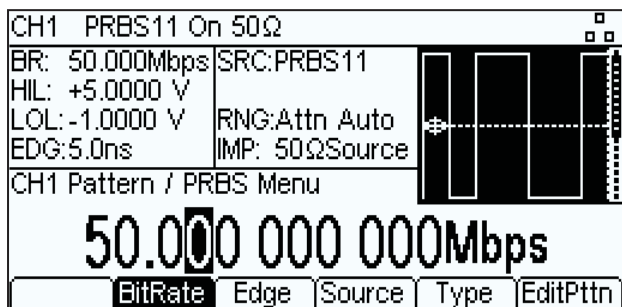

A PRBS is generated by a linear-feedback shift register with taps that generate a feedback signal via an exclusive-OR gate. The number of stages determines the sequence length (2N-1) whilst the clock frequency determines the bit rate.

LFSR lengths between 7 and 31 can be selected giving pattern lengths up to 2,147,483,647 bits.

Extensive Pulse Modulations

In addition to pulse width modulation (PWM) the TGP3100 Series offers pulse delay modulation, amplitude modulation, amplitude summing with other waveforms, frequency and phase modulations, plus FSK frequency keying and BPSK phase shift keying.

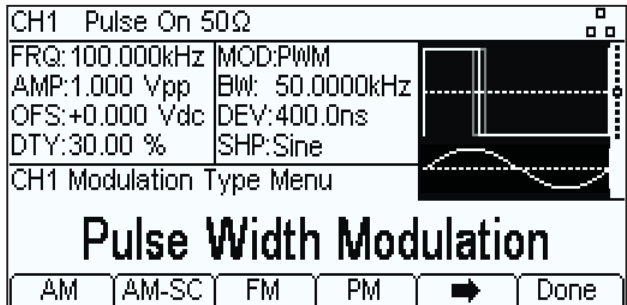

The modulation source can be internal or external. A very wide range of internal modulating waveforms are available.

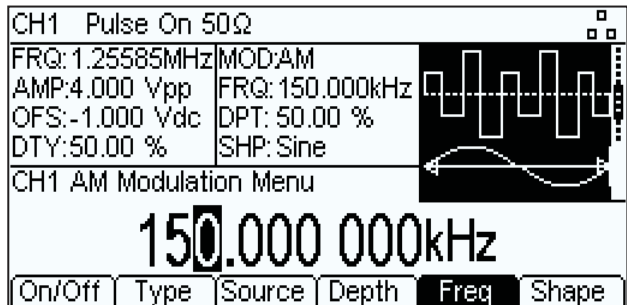

Modulating with Noise and Jitter Simulation

As well all of the standard modulating waveforms of sine, square, ramp (and more than a dozen others) waveforms can be modulated using noise, or summed with noise.

For example, PDM can be used to create jitter simulation by randomly modulating the edge positions.

The noise source is fully controllable in terms of noise bandwidth and amplitude distribution (see page 6 for information on noise generation).

Pulse Sweep

Pulse repetition frequency can be swept over the full frequency range with fully variable up, down and dwell times. Sweeps can be linear or logarithmic. The sweep trigger source can be internal or external.

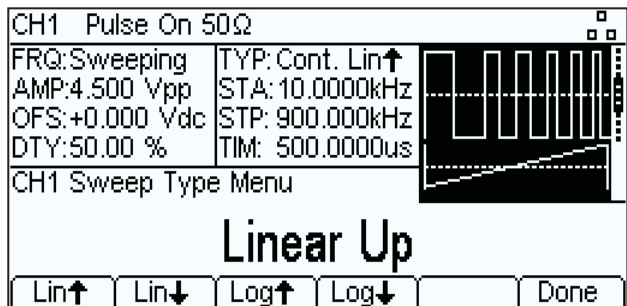

A marker pulse can be generated from the Sync output at any frequency within the sweep span.

High Performance Noise Generator

The TGP3100 Series can act as high performance noise generators of variable bandwidth and amplitude distribution.

Noise can be used as a main carrier waveform or as a modulation source for other waveforms. For example it can be used to generate edge jitter on pulse waveforms.

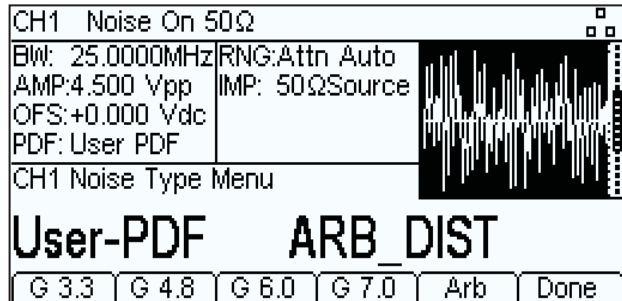

Noise bandwidth can be set anywhere between 0.1Hz and 25MHz (12.5MHz on TGP312x models).

Amplitude distribution can be gaussian with variable crest factor or it can be fully user defined.

Waveform Manager Plus

Waveform Manager Plus (version 4) is a Windows* based application for creation, editing and management of arbitrary waveforms and pulse patterns using a PC.

It incorporates a complete suite of tools for waveform creation and editing including standard waveforms, mathematical expressions and freehand drawing.

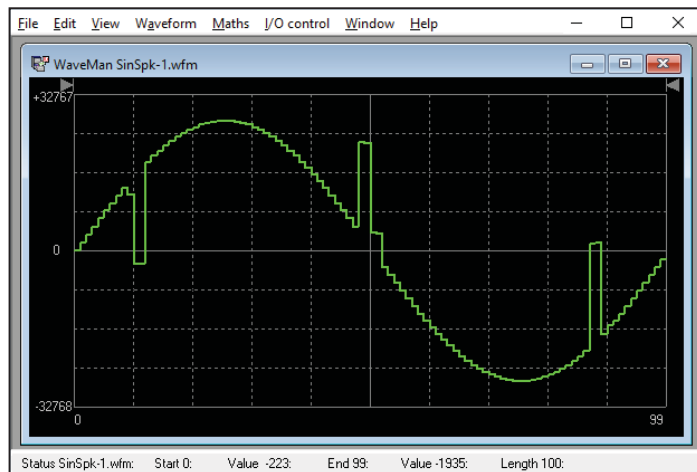

The program offers direct import from .csv files, the most commonly used format for graphical description. Additionally a Clipboard import function supports any waveform that can be described by a set of Y-axis data points regardless of their format.

Any instrument or waveform generating program that can create a list of Y values can therefore be accommodated. This is a highly flexible method which can be used to create arbitrary generator waveforms from signals captured by instruments such as oscilloscopes and network analysers, or from software such as MathCad.

Full Function/Arbitrary Generator

As well as operating as a pulse generator and noise generator, the TGP3100 Series can operate as a high performance function and arbitrary generator.

Waveform frequency is settable from 1mHz up to 50MHz (25MHz on TGP312x models) with 11 digit or 1mHz resolution.

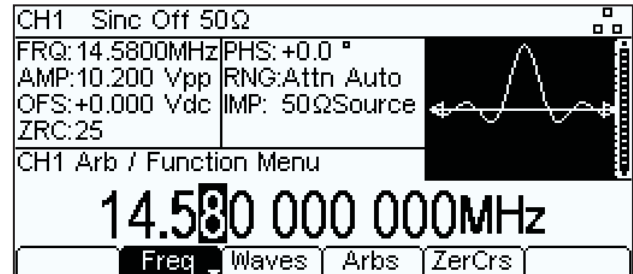

Standard waveforms include Sine, Rectangular, Ramps, Sin(x)/x, Haversine, Logarithmics, Exponentials, Gaussian/Lorentz and Cardiac.



Arbitrary Waveforms

As an arbitrary generator sampling rate is an impressive 800MS/s enabling relatively complex waveshapes to be replayed at high frequencies.

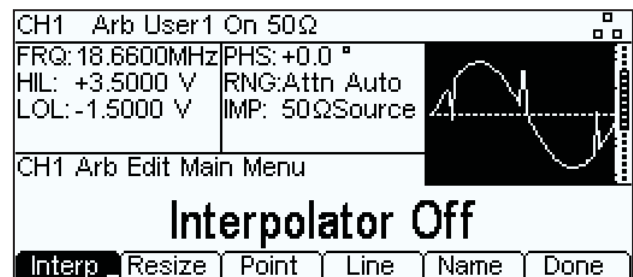

Waveform length is up to 4096 samples. Four waveforms can be stored within the instrument with unlimited numbers available using the Flash drive interface or uploaded from the digital interfaces.

High Output Levels

As a noise or arbitrary/function generator, the TGP3100 Series retains its high output level capability that can drive 20 volts pk-pk in 50Ω. See page 4 for more information.

* Windows is a trademark of Microsoft Inc.

Digital Modulation, Internal & External

As with pulse waveforms, all function and arbitrary waveforms can be digitally modulated.

The internal modulation source can use any of the standard or arbitrary waveforms currently within the generator (including noise and PRBS) thus removing the need for an external modulation source. A modulating frequency between 1mHz and 10MHz can be specified.

An external modulation input enables any external waveform source to be used when required. The external bandwidth is DC to 5MHz.

AM, AM-SC, FM and PM

Waveforms can be modulated using amplitude, suppressed carrier amplitude, frequency or phase modulation.

Amplitude depth is variable from 0.0% to 100.0%, frequency deviation from zero to Fmax, and phase deviation from -360.0 to +360.0 degrees.

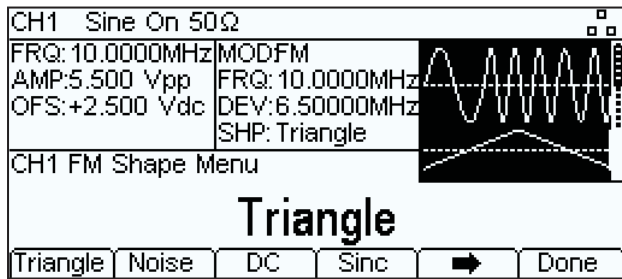

Sum

Sum modulation adds the modulating waveform to the carrier. It can be used with all carrier waveform types along with any modulating waveform.

FSK and BPSK

Frequency shift keying between any two frequencies is available for sine, square, ramp or arbitrary waveforms using the internal trigger generator or an external trigger signal.

The internal trigger generator is variable between 2mHz and 50MHz (25MHz on TGP312x models).

BPSK (Binary Phase Shift Keying) is similar to FSK but it is the carrier's phase, rather than its frequency, that switches between two values. It has advantages in terms of bandwidth used.

PRBS

A PRBS waveform can be used as a modulating waveform at bit rates between 1mbps to 10Mbps.

Sweep and Burst

As with pulse waveforms, all function and arbitrary waveforms can be operated in Sweep, Burst and Gated modes using either an external trigger signal or the internal trigger generator.

Wide range Frequency Sweep

Phase continuous sweep is available for all standard and arbitrary waveforms. The sweep range is from 1mHz through to the maximum for the chosen carrier waveform. Start and stop frequencies can be set independently.

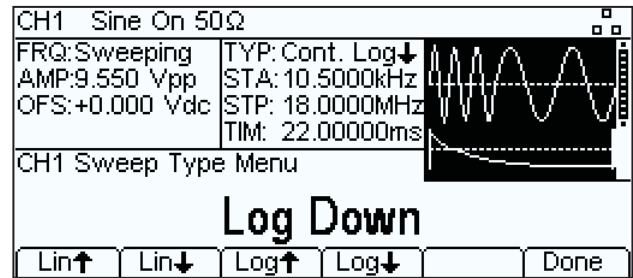

The sweep can be linear or logarithmic, triggered or continuous with a period between 1ms and 500s. The sweep trigger can be manual or internal from the trigger generator or external from the trigger socket or from a remote interface command.

A marker is provided that outputs an edge synchronous with any frequency point within the sweep.

Triggered Burst

In Burst mode, each active edge of the trigger will produce one burst of the waveform.

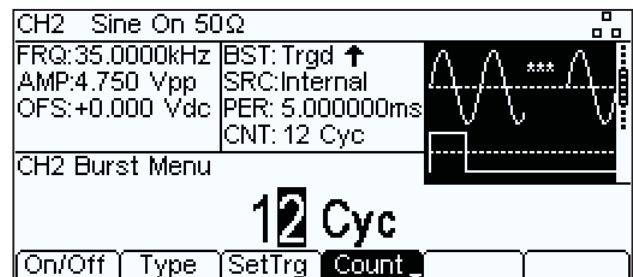

The number of cycles in a burst can be set between 1 and 4,294,967,295 (or infinite). The burst starts and ends at a waveform phase angle settable between -360.0 to +360.0 degrees.

Trigger signal

The trigger signal can be manual from the front panel key, internal from the internal trigger generator, external from the trigger-in socket, or remote via a bus command.

The trigger-in socket has a nominal TTL threshold and can be set to +ve edge or -ve edge triggering. The minimum trigger pulse width is 50ns.

Gated

In Gated mode the waveform runs only when the gate signal is true. The start point of the waveform is settable from -360.0 to +360.0 degrees and a the last cycle is completed after the gate signal goes false.

All of the options available for triggering are available for gating. The trigger-in socket can be set as high or low for true.

Two Channel Operation

(TGP3122 & TGP3152 only)

The generators are available in one channel or two channel versions, the latter incorporating two outputs with identical capabilities.

On two channel generators, both channels provide the full performance and specification, along with entirely independent operation when required.

The two channel models represent excellent value for money when compared to purchasing two generators.

Independent Channel Operation

The two channels can be operated completely independently as if they were two separate generators.

Note, however, that the channels share a common external modulation and common external trigger input.

Coupled Operation

The frequencies of the two channels can be coupled such that if frequency of one channel is changed the frequency of the other channel also changes either by a fixed ratio or fixed offset.

Amplitudes (and DC offsets) of the two channels can be coupled such that changing the amplitude and offset on one channel changes the amplitude and offset of both channels.

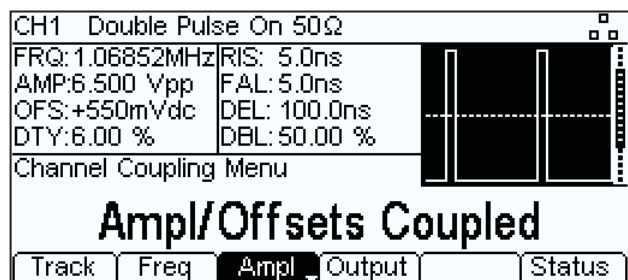

Outputs of the two channels can be coupled such that switching the output on/off on one channel switches the output on/off of both channels.

Tracking Operation

When in tracking mode both channels behave as one channel. If inverse tracking is selected, both channel still behave as one channel except that the output of channel 2 is inverted.

Relative Phase

The relative phase can be set from -360 degrees to +360 degrees with 0.001 degree resolution. Pressing the 'align' key phase synchronises the two channels with the specified phase offset.

Locking to Other Sources

The TGP3100 Series includes external reference and phase locking as standard.

External Frequency Reference

The generators use a high quality TCXO crystal as the internal frequency reference providing 1ppm accuracy and stability.

If a higher accuracy or stability is required, an external 10MHz reference signal (from an off-air standard for example) can be applied to the Ref. Clock input.

Phase Locking Two Generators (or more)

Two generators can be synchronised to provide outputs at the same frequency (or at harmonics) and with a phase difference.

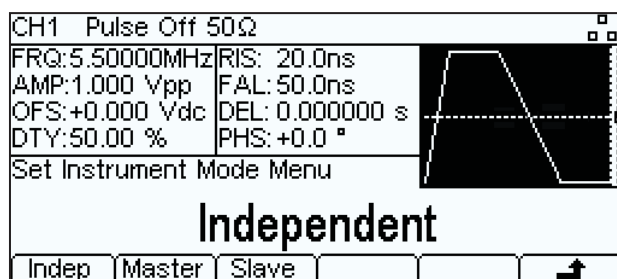

The amplitude and phase of these outputs can also be modulated providing the capability to perform QAM and QPSK respectively.

Any waveform other than Patterns/PRBS or Noise can be used. The phase difference is adjustable between -360.0 and +360.0 to a resolution of 0.001 degrees.

N.B. In the case of two channel generators, when phase synchronising is performed the two channels of each generator are also synchronised providing four synchronous waveforms.

It is also possible to synchronise more than two generators but the resulting precision is not specified.

Filing System

Patterns, Waveforms and Set-up files can be given user-defined names within the instrument.

USB Flash Drive Interface

A front mounted USB socket is incorporated for connection of flash memory disk drives which can store up to 1,000 patterns or waveforms and 1,000 setups.

CH1 Pulse Off 50Ω		Disk: Waveforms	
Local: Waveforms		Disk: Waveforms	
➔ ARB-AG5	1024	➔ ARB-AG5	1024
2 NTNTEST4	100	ARB-AK1	220
3 ARB-BF2	446	ARB-BF2	446
4 BRB4	16	PTN-A,A9	100
		PTN-AB4	100
Source	Copy	Delete	Done

Unlimited Waveform/Pattern Storage

These drives can be used both to store waveforms permanently and to transfer waveforms from or to a PC.

Arbitrary waveform storage within the instrument is limited to four patterns and four waveforms. Each flash drive can store up to 1000 patterns/waveforms which can be accessed using the instruments file handling utilities.

Storage of Instrument Set-ups

Up to nine complete set-ups of the instrument can be stored within its own non-volatile memory. Up to 1000 further set-ups can be stored on each flash drive.



Rear panel mounting of digital interfaces and I/O connectors.

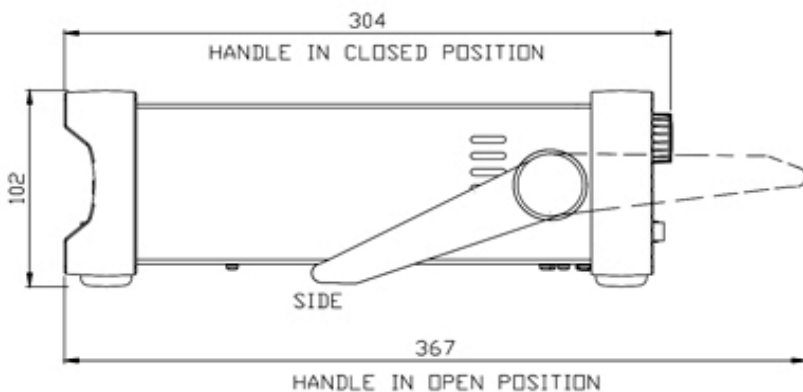

Comprehensive Remote Connectivity

GPIB, USB and LAN interfaces are all fitted as standard. All functions of the generators can be controlled from the digital interfaces. Arbitrary waveform data and pulse patterns can also be loaded using these interfaces.

An IVI driver for Windows is supplied. This provides support for common applications such as LabView*, LabWindows* and HP-VEE*.



The LAN interface uses a standard 10/100 base-T Ethernet hardware connection with ICMP and TCP/IP Protocol for connection to a Local Area Network or direct connection to a single PC.

This interface supports LXI and is the most appropriate for larger system use because of its scalable nature.



The LAN interface is compliant with LXI (LAN eXtensions for Instrumentation).

LXI is the next-generation, LAN-based modular architecture standard for automated test systems managed by the LXI Consortium, and is expected to become the successor to GPIB in many systems.



USB provides a simple and convenient means of connection to a PC and is particularly appropriate for small system use. USB has effectively replaced RS232 in many applications.

The interface uses a standard USB 2.0 hardware connection and is implemented as virtual-COM port. A Windows* USB driver is provided.

As well as the rear mounted USB device interface connector, a front mounted USB Host interface connector allows USB Flash memory to be connected.



The GPIB interface is compliant with IEEE-488.1 and IEEE-488.2. Currently GPIB remains the most widely used interface for system applications.

* LabView and LabWindows are trademarks of National Instruments. HPVEE (now Agilent VEE) is a trademark of Agilent Technologies.

* USB interface is supported for Windows 2000, XP, Vista and Windows 7 and 8. Windows is a trademark of Microsoft Inc.

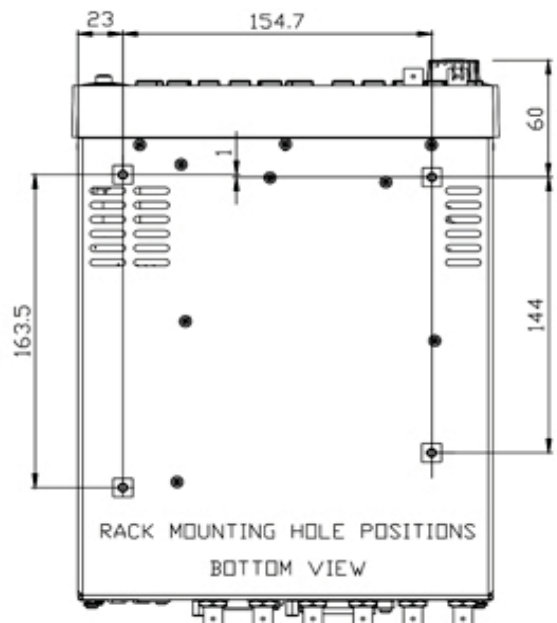

Note that specifications apply to 50MHz models (TGP3151 and TGP3152) and that specifications for 25MHz models (TGP3121 and TGP3122), where different, are in [square brackets] directly following the 50MHz specifications.

For two channel models (TGP3122 and TGP3152) specification apply to each output.

Standard Waveforms

Pulse, Square, Double Pulse, Pattern, PRBS (Pseudo Random Binary Sequence), Noise, Pre Defined Function Waveforms (Sine, Square (User Defined Duty Cycle), Triangle, Ramp (User Defined Symmetry), Negative Ramp, DC, Sin(x)/x (User Defined Zero Crossings), Exponential Rise (User Defined Time Constant), Exponential Fall (User Defined Time Constant), Logarithmic Rise (User Defined Time Constant), Logarithmic Fall (User Defined Time Constant), Haversine, Gaussian (User Defined Width), Lorentz (User Defined Width), D-Lorentz and Cardiac) and 4 User Defined Arbitrary Waveforms.

Pulse

Frequency Range:	1mHz to 50MHz [1mHz to 25MHz]
Frequency Resolution:	1mHz, 11 digits
Jitter RMS:	<30ps (cycle to cycle)
Abserrations (Typical):	±5% of amplitude (for transition time 5ns); ±3% of amplitude (for transition time 10ns); <±2% of amplitude (for transition time > 20ns)
Period	Period can also be entered as frequency Range: 20ns to 1000s [40ns to 1000s] Resolution: 100ps
Width	Width can be entered as absolute width, duty cycle or fall time delay Range: 10ns to 999.9999999s [20ns to 999.9999998s] Resolution: 100ps Accuracy: ±200ps ±0.01% of period
Delay	Delay can be entered as absolute delay, phase or % of period Range: 0ns to 999.99999998s [0ns to 999.99999996s] Resolution: 100ps Accuracy: ±200ps ±0.01% of period
Transition Time	Rise and Fall times can be independently varied or can be varied together simultaneously and can be entered as absolute rise/fall time or as a % of width Range: 5ns to 799.99999989s (10% to 90%) [8ns to 799.99999984s] Resolution: 100ps Accuracy: ±500ps ±0.01% of period

Double Pulse

Frequency Range:	1mHz to 25MHz [1mHz to 12.5MHz]
Frequency Resolution:	1mHz, 11 digits
Jitter RMS:	<30ps (cycle to cycle)
Abserrations (Typical):	±5% of amplitude (for transition time 5ns); ±3% of amplitude (for transition time 10ns); <±2% of amplitude (for transition time > 20ns)
Period	Period can also be entered as frequency Range: 40ns to 1000s [80ns to 1000s] Resolution: 100ps
Width	Width can be entered as absolute width, duty cycle or fall time delay Range: 10ns to 499.9999999s [20ns to 499.9999998s] Resolution: 100ps Accuracy: ±200ps ±0.01% of period
Delay	Delay can be entered as absolute delay, phase or % of period Range: 0ns to 999.99999996s [0ns to 999.99999992s] Resolution: 100ps Accuracy: ±200ps ±0.01% of period
Transition Time	Rise and Fall times can be independently varied or can be varied together simultaneously and can be entered as absolute rise/fall time or as a % of width Range: 5ns to 399.99999989s (10% to 90%) [8ns to 399.99999984s] Resolution: 100ps Accuracy: ±500ps ±0.01% of period
Double Delay	Double delay is the delay from the start of the first pulse to the start of the second pulse. Range: 20ns to 999.9999998ns [40ns to 999.9999996ns] Resolution: 100ps Accuracy: ±200ps ±0.01% of period

Square

Frequency Range:	1mHz to 50MHz [1mHz to 25MHz]
Frequency Resolution:	1mHz, 11 digits
Jitter RMS:	<30ps (cycle to cycle)
Abserrations (Typical):	±5% of amplitude [±3% of amplitude]
Period	Period can also be entered as frequency Range: 20ns to 1000s [40ns to 1000s] Resolution: 100ps
Duty Cycle	Range: 0.1% to 99.9% Resolution: 0.1%
Transition Time	(Rise and Fall) 5ns Fixed [8ns Fixed]

Pattern/PRBS

Bit Rate:	1mbps to 50Mbps [1mbps to 25Mbps]
Bit Rate Resolution:	1mbps, 11 digits
Pattern Source:	Internal from memory (memory size of 65536 bits with 1 bit resolution, user-defined). Up to 4 user-defined patterns may be stored in non-volatile memory. Patterns can be defined by downloading of pattern data via remote interfaces or from instrument's front panel.
Internal PRBS:	Sequence Length $2^m - 1$, where $m = 7, 9, 11, 15, 20, 23, 29, 31$
External 1:	Pattern is applied at External Modulation Input. Indefinite pattern length. Upto 5Mbps. Pattern is sampled at 50Mbps with user defined pattern threshold level.
External 2:	(External Width) Pattern is applied at External TRIG IN. Indefinite Pattern Length. Upto 50Mbps [25Mbps]. Fixed latency.
Transition Time	Rise and Fall times can be independently varied or can be varied together simultaneously and can be entered as absolute rise/fall time or as a % of width Range: 5ns to 799.99999989s (10% to 90%) [8ns to 799.99999984s] Resolution: 100ps
Noise	
Bandwidth	Defines the bandwidth in which the energy of the noise signal is concentrated Range: 1mHz to 25MHz [1mHz to 12.5MHz] Resolution: 1mHz, 11 digits
Noise sampling rate	is 3.2 times the specified bandwidth. DAC sampling rate is fixed at 800MSa/s. Intermediate points are calculated by interpolation. Frequency response follows Sin(x) / x (or Sinc) characteristic. Stopband attenuation of first aliasing / image band is 30dB, typical.
Noise Distribution:	(Amplitude Distribution) Gaussian or user-defined (user-defined waveform defines how often a level will occur relative to all others). Waveform memory size is 2048 points.
Waveform	is stored in non-volatile memory. Waveform can be defined by downloading of waveform data via remote interfaces or from instrument's front panel.
Crest Factor (Gaussian):	3.3, 4.8, 6.0, 7.0, Typical
Repetition Time:	> 10 years

Function

Waveforms:	Sine, Square (User Defined Duty Cycle 1.0% - 99.0%), Triangle, Ramp (User Defined Symmetry 0.0% - 100.0%), Negative Ramp, DC, Sin(x)/x (User Defined Zero Crossings 4 - 50), Exponential Rise (User Defined Time Constant 1.0% - 100.0%), Exponential Fall (User Defined Time Constant 1.0% - 100.0%), Logarithmic Rise (User Defined Time Constant 1.0% - 100.0%), Logarithmic Fall (User Defined Time Constant 1.0% - 100.0%), Haversine, Gaussian (User Defined Width 1.0% - 100.0%), Lorentz (User Defined Width 1.0% - 100.0%), D-Lorentz and Cardiac
Waveform Memory Size	4096 points
Vertical Resolution:	16 bits
Frequency Range:	1mHz to 50MHz [1mHz to 25MHz]
Frequency Resolution:	1mHz, 11 digits
Sampling Rate:	800MSa/s
Point to Point Jitter:	1.25ns Typical
Sine Flatness:	<100kHz 0.1dB <5MHz 0.5dB <25MHz 1.25dB <50MHz 1.75dB
(amplitude flatness)	
Sine Distortion:	at level <1 Vp-p > 1Vp-p DC to 10MHz -60dBc -60dBc 10 to 50MHz -50dBc -40dBc
Sine Spuri:	(non harmonic) <-65dBc
Sine Phase Noise:	(10kHz offset) -113dBc/Hz, Typical
Ramp Linearity Error:	<0.1% to 200 kHz

Arbitrary

Waveforms	Up to 4 user-defined waveforms may be stored in non-volatile memory. Waveforms can be defined by downloading of waveform data via remote interfaces or from instrument's front panel.
Waveform Size	4096 points
Vertical Resolution:	16 bits
Frequency Range:	1mHz to 50MHz [1mHz to 25MHz]
Frequency Resolution:	1mHz, 11 digits
Sampling Rate:	800MSa/s
Point to Point Jitter:	1.25ns Typical
Internal Frequency Reference	
Internal Setting Error:	< ± 2ppm
Oscillator Ageing Rate:	< ± 1ppm first year
Temperature Stability:	< 1ppm over the specified temperature range

Modulation

AM (Amplitude Modulation) Normal & Suppressed Carrier

Carrier Waveforms: Pulse, Double Pulse, Square, Pattern/PRBS, Noise, Function, Arb
 Modulation Source: Internal / External / (Other Channel on 2 channel models)
 Internal Waveforms: Sine, Square, Positive Ramp, Negative Ramp, Triangle, Gaussian Noise, DC, Sinc, Exponential Rise, Exponential Fall, Logarithmic Rise, Logarithmic Fall, Haversine, Gaussian, Lorentz, D-Lorentz, Cardiac, PRBS-PN7, PN9, PN11, PN15, PN20, PN23, PN29, PN31 and User Defined Arbs
 Internal Frequency: 1mHz to 10MHz, 1mHz resolution
 Amplitude Depth: 0.0% to 100%, 0.1% resolution

FM (Frequency Modulation)

Carrier Waveforms: Pulse (width, delay and edges are fixed when modulated), Double Pulse (width, delay, double delay and edges are fixed when modulated), Square (width is fixed when modulated), Pattern/PRBS (edges are fixed when modulated), Function (square duty cycle is fixed when modulated), Arb
 Modulation Source: Internal / External / (Other Channel on 2 channel models)
 Internal Waveforms: Sine, Square, Positive Ramp, Negative Ramp, Triangle, Gaussian Noise, DC, Sinc, Exponential Rise, Exponential Fall, Logarithmic Rise, Logarithmic Fall, Haversine, Gaussian, Lorentz, D-Lorentz, Cardiac, PRBS-PN7, PN9, PN11, PN15, PN20, PN23, PN29, PN31 and User Defined Arbs
 Internal Frequency: 1mHz to 10MHz, 1mHz resolution
 Frequency Deviation: DC to $F_{max}/2$, 1mHz resolution

PM (Phase Modulation)

Carrier Waveforms: Pulse, Double Pulse, Square, Function, Arb
 Modulation Source: Internal / External / (Other Channel on 2 channel models)
 Internal Waveforms: Sine, Square, Positive Ramp, Negative Ramp, Triangle, Gaussian Noise, DC, Sinc, Exponential Rise, Exponential Fall, Logarithmic Rise, Logarithmic Fall, Haversine, Gaussian, Lorentz, D-Lorentz, Cardiac, PRBS-PN7, PN9, PN11, PN15, PN20, PN23, PN29, PN31 and User Defined Arbs
 Internal Frequency: 1mHz to 10MHz, 1mHz resolution
 Phase Deviation: -360.0 to +360.0 degrees, 0.001 degree resolution

FSK (Frequency Shift Keying)

Carrier Waveforms: Pulse (width, delay and edges are fixed when modulated), Double Pulse (width, delay, double delay and edges are fixed when modulated), Square (width is fixed when modulated), Pattern/PRBS (edges are fixed when modulated), Arb
 Source: Internal / External (via TRIG IN)
 Internal Modulation: 2mHz to 10MHz, 1mHz resolution (50% duty cycle square)

BPSK (Binary Phase Shift Keying)

Carrier Waveforms: Pulse, Double Pulse, Square, Function, Arb
 Source: Internal / External (via TRIG IN)
 Internal Modulation: 2mHz to 10MHz, 1mHz resolution (50% duty cycle square)

SUM (Additive Modulation)

Carrier Waveforms: Pulse, Double Pulse, Square, Pattern/PRBS, Noise, Function, Arb
 Modulation Source: Internal / External / (Other Channel)
 Internal Waveforms: Sine, Square, Positive Ramp, Negative Ramp, Triangle, Gaussian Noise, DC, Sinc, Exponential Rise, Exponential Fall, Logarithmic Rise, Logarithmic Fall, Haversine, Gaussian, Lorentz, D-Lorentz, Cardiac, PRBS-PN7, PN9, PN11, PN15, PN20, PN23, PN29, PN31 and User Defined Arbs
 Internal Frequency: 1mHz to 10MHz, 1mHz resolution
 Amplitude Depth: 0.0% to 100.0%, 0.1% resolution

PWM (Pulse Width Modulation)

Carrier Waveforms: Pulse, Double Pulse
 Modulation Source: Internal / External / (Other Channel on 2 channel models)
 Internal Waveforms: Sine, Square, Positive Ramp, Negative Ramp, Triangle, Gaussian Noise, DC, Sinc, Exponential Rise, Exponential Fall, Logarithmic Rise, Logarithmic Fall, Haversine, Gaussian, Lorentz, D-Lorentz, Cardiac, PRBS-PN7, PN9, PN11, PN15, PN20, PN23, PN29, PN31 and User Defined Arbs
 Internal Frequency: 1mHz to 10MHz, 1mHz resolution
 Width Deviation: 0% to 100% of pulse width (subject to pulse width limits), resolution same as of pulse width

PDM (Pulse Delay Modulation)

Carrier Waveforms: Pulse, Double Pulse
 Modulation Source: Internal / External / (Other Channel on 2 channel models)
 Internal Waveforms: Sine, Square, Positive Ramp, Negative Ramp, Triangle, Gaussian Noise, DC, Sinc, Exponential Rise, Exponential Fall, Logarithmic Rise, Logarithmic Fall, Haversine, Gaussian, Lorentz, D-Lorentz, Cardiac, PRBS-PN7, PN9, PN11, PN15, PN20, PN23, PN29, PN31 and User Defined Arbs
 Internal Frequency: 1mHz to 10MHz, 1mHz resolution
 Delay Deviation: 0% to 100% of pulse delay (subject to pulse delay limits), resolution same as of pulse delay

SPDM (Second Pulse Delay Modulation)

Carrier Waveforms: Double Pulse
 Modulation Source: Internal / External / (Other Channel on 2 channel models)
 Internal Waveforms: Sine, Square, Positive Ramp, Negative Ramp, Triangle, Gaussian Noise, DC, Sinc, Exponential Rise, Exponential Fall, Logarithmic Rise, Logarithmic Fall, Haversine, Gaussian, Lorentz, D-Lorentz, Cardiac, PRBS-PN7, PN9, PN11, PN15, PN20, PN23, PN29, PN31 and User Defined Arbs
 Internal Frequency: 1mHz to 10MHz, 1mHz resolution
 Delay Deviation: 0% to 100% of double delay (subject to double delay limits), resolution same as of double delay

Gated Burst

Waveform will run while the Gate signal is true and stop while false. Starts synchronously with the input edge.
 Carrier Waveforms: Pulse, Double Pulse, Square, Pattern/PRBS, Noise, Function, Arb
 Trigger Rep. Rate: 2mHz to 50MHz [25MHz] internal (10ns period resolution) DC to 50MHz [25MHz] external.
 Gate Signal Source: Internal from keyboard, trigger generator. External from TRIG IN or remote interface.
 Gate Phase: (start/stop phase) -360.0 to +360.0 degrees, 0.001 degree resolution (Phase offset cannot be set for Noise and Pattern / PRBS waveforms)

Triggered Burst

Selected active edge will produce one burst of the waveform
 Carrier Waveforms: Pulse, Double Pulse, Square, Function, Arb
 Pattern/PRBS: Selectable 'Bit' or 'Block' mode. In bit mode a fixed number of bits (specified as number of cycles) are generated at every trigger event. In block mode the whole pattern is generated at every trigger event.
 Noise is reset to its start condition at every trigger event. Allows generating same random noise sequence.
 Number of Cycles: 1 to 4294967295 and infinite
 Trigger Rep. Rate: 2mHz to 50MHz [25MHz] internal (10ns period resolution) DC to 50MHz [25MHz] external.
 Gate Signal Source: Internal from keyboard, trigger generator. External from TRIG IN or remote interface.
 Gate Phase: (start/stop phase) -360.0 to +360.0 degrees, 0.001 degree resolution (Phase offset cannot be set for Noise and Pattern / PRBS waveforms)

Sweep

Frequency sweep capability is provided for all standard (except noise) and arbitrary waveforms.
 Carrier Waveforms: Pulse (width, delay and edges are fixed when modulated), Double Pulse (width, delay, double delay and edges are fixed when modulated), Square (width is fixed when modulated), Pattern/PRBS (edges are fixed when modulated), Function (square duty cycle is fixed when modulated), Arb
 Sweep Mode: Linear or logarithmic, triggered or continuous.
 Sweep Direction: Up or Down
 Sweep Range: From 1mHz to 50MHz [25MHz]. Phase continuous. Independent setting of the start and stop frequency.
 Sweep Time: 100µs to 50s
 Hold Time: 100µs to 50s
 Return Time: 100µs to 50s
 Trigger Source: The sweep may be free run or triggered from the following sources:
 Internal from keyboard or trigger generator.
 Externally from TRIG IN input or remote interface.

Trigger Generator

Internal source 2mHz to 50MHz [25MHz] square wave adjustable in 10ns steps, 11 digit resolution. Available for external use from the SYNC OUT socket.

Dual-channel Operations (TGP3122 and TGP3152 only)

Tracking

Independent (Off): The channels are independent of each other.
 Equal: The two channels are identical and behave identically.
 Inverse: The two channels are identical except that the output of channel 2 is inverted. In this mode the two channels can be used together as a differential signal source.

Coupling

Frequency Coupling: The frequencies of the two channels can be coupled. Changing the frequency of one channel changes the frequency of the other channel, either by a fixed ratio or fixed offset.
 Waveforms: Pulse, Double Pulse, Square, Function, Arb. Noise and Pattern / PRBS cannot be frequency coupled.
 Type: Ratio 1 to 1000, resolution 0.001
 Offset +/- 50MHz [+/- 25MHz] -1mHz, resolution 1mHz
 Amplitude Coupling: Amplitude (and DC offset) of the two channels can be coupled. Changing the amplitude and offset on one channel changes the amplitude and offset of both channels.
 Output Coupling: Output On/Off can be coupled. Switching the output On/Off on one channel switches the output On/Off of both channels.

Technical Specifications (continued)

Digital Channel Addition

Channel 2 can be added to Channel1 (using SUM modulation - modulation source: other channel) and vice versa. The maximum output voltage of the combined output remains unchanged. The uncombined channel still outputs the unchanged waveform.

Channel to Channel Characteristics

Relative Phase: -360 to 360 degrees, 0.001 degree resolution
(Phase offset cannot be set for Noise and Pattern / PRBS waveforms)
Channel Skew: <1ns (typical) - when performing identical operations
Crosstalk (Typical): <-80db

Outputs

Main Output

Source Impedance 5Ω or 50Ω selectable
Amplitude can be specified open circuit (hi Z) or into an assumed load of 50Ω to 10kΩ in Vpp
Amplitude: 50Ω into 50Ω -100mVpp to 11Vpp
5Ω into 50Ω -200mVpp to 20Vpp
5Ω / 50Ω into open circuit -200mVpp to 22Vpp
Amplitude Accuracy: 1.5% ±5mV at 1kHz for 50Ω into 50Ω
DC Offset Range: 50Ω into 50Ω - ±5.5V. DC offset plus signal peak limited to ±5.5V
5Ω into 50Ω - ±10V. DC offset plus signal peak limited to ±10V
5Ω / 50Ω into open circuit - ±11V. DC offset plus signal peak limited to ±11V
DC Offset Accuracy: Typically 1% ±50mV.
Resolution: 3 digits or 1mV for both Amplitude and DC Offset.

Sync Outs

Multifunction output automatically selected to be any of the following. User can choose Sync to always be carrier referenced, to output the currently used trigger signal or turn it off.

Carrier Waveform Sync:

Pulse / Square / Double Pulse / Function / Arbs:

A square wave with 50% duty cycle at the waveform frequency.

Pattern / PRBS:

Internal Source - a positive pulse which is 1 bit rate wide at the beginning of the sequence

External Source - a square wave with same duty cycle and frequency as the external source.

Noise:

No sync associated with noise.

Modulation Sync:

AM/FM/PM/SUM/PWM/PDM/SPDM:

A square wave with 50% duty cycle referenced to the internal modulation waveform when modulation source is internal, or a square wave referenced to the carrier waveform when modulation source is external. No sync is associated with noise as the modulation source.

FSK - A square wave referenced to the trigger rate. The sync is a TTL high when hop frequency is the output frequency and TTL low when carrier frequency is the output frequency for positive slope and vice versa for negative slope.

BPSK:

A square wave referenced to the trigger rate. The sync is a TTL high when the hop phase is the output phase and TTL low when carrier phase is the output phase for positive slope and vice versa for negative slope.

Sweep Sync:

Marker Off:

A square wave that is a TTL high from the beginning of the sweep and a TTL low from the midpoint of the sweep

Marker On:

A square wave that is a TTL high from the beginning of the sweep and a TTL low from the marker frequency

Burst Sync:

Internal Trigger: A square wave with 50% duty cycle at the trigger frequency.

External Trigger: A square wave with same duty cycle and frequency as the external source.

Manual Trigger: A positive pulse which is approximately 18us wide at the beginning of the event.

Trigger Sync:

All Trigger Types Outputs the current trigger signal.

Sync Alignment:

Sync to Output Delay 0.0ns typical.

Sync Output:

Output Signal Level: Logic level nominally 3V

Output Impedance: 50Ω

Ref Clock Output

Buffered version of the 10MHz clock currently in use (internal or external)

Output Level: Nominally 3V logic level from 50Ω

Trigger Input

For FSK, BPSK, triggered sweep, gated burst, triggered burst, external pattern (external width)

Threshold: ±3V

Maximum Input: ±10V

Min. Pulse Width: 10ns [20ns]

Frequency Range: DC to 50MHz [DC to 25MHz]

Polarity: Selectable as high/rising edge or low/falling edge.

Input Impedance: 10kΩ

Trigger Delay (Fixed) 448ns (Trigger to Output, typical)

Trigger to Output Jitter 60ps RMS (typical)

Valid for externally triggered pulse, square, double pulse, internal pattern / PRBS, arb / function, external pattern (external width). Measured with 50Ω source impedance at main output. Trigger amplitude >500mV, transition time <10ns.

Externally triggered noise, sweep, FSK and BPSK has peak to peak jitter of 5ns.

External Modulation Input

For AM, FM, PM, SUM, PWM, PDM, SPDM, external pattern

Voltage Range: ±2.5V full scale

Input Impedance: 5kΩ Typical

Bandwidth: DC to 5MHz

Ref Clock Input

Input for an external 10MHz reference clock

Voltage Range: 1Vp-p – 5Vp-p

Maximum Voltage: +5V

Minimum Voltage: -1V

Digital Interfaces

Full digital remote control facilities are available through LAN, USB and GPIB interfaces.

LAN Interface Ethernet 100/10base – T hardware connection. LXI Core 2011.

USB Interface Standard USB 2.0 hardware connection. Implemented as virtual-COM port.

USB Flash Drive For waveform and set-up storage/recall.

GPIB (optional) Conforming with IEEE488.1 and IEEE488.2

Driver Software Supplied

IVI Driver:

An IVI driver for Windows is supplied. This provides support for common applications such as LabView*, LabWindows*, HPVVE* etc. Full installation for CVI and LabVIEW instrument drivers.

LV/CVI Driver:

An installation file is supplied calling a standard Windows* USB driver.

* LabView and LabWindows are trademarks of National Instruments.

HPVVE (now Agilent VEE) is a trademark of Agilent Technologies.

* USB interface is supported for Windows 2000 and above (inc. 64-bit versions)

Windows is a trademark of Microsoft.

General

Display: 256 x 112 pixel monochrome graphics display. White LED backlight with adjustable brightness and contrast. Black-on-white or inverse modes.

Data Entry: Keyboard selection of mode, waveform etc.; value entry direct by numeric keys or by rotary control.

Stored Settings: Up to 9 complete instrument set-ups may be stored and recalled from non-volatile memory.

Size: Bench Top: 97mm height; 250mm width; 295mm long
Rack mount: 86.5mm (2U) height; 213.5mm (1/2-rack) width; 269mm long

Weight: 3.2kg

Power: 100-240VAC ±10% 50/60Hz; 100-120VAC ±10% 400Hz; 60VA max. Installation Category II.

Operating Range: +5°C to 40°C, 20-80% RH.

Storage Range: -20°C to + 60°C.

Environmental: Indoor use at altitudes up to 2000m, Pollution Degree 2.

Options: 19 inch rack mounting kit.

Safety: Complies with EN61010-1.

EMC: Complies with EN61326

OPTIONS

Rack Mount (RM200A)

19 inch 2U rack mount suitable for one or two generators.

Distribution in the UK & Ireland



**Characterisation,
Measurement &
Analysis**

Lambda Photometrics Limited
Lambda House Batford Mill
Harpenden Herts AL5 5BZ
United Kingdom

E: info@lambdaphoto.co.uk

W: www.lambdaphoto.co.uk

T: +44 (0)1582 764334

F: +44 (0)1582 712084